



The power behind competitiveness

Delta UPS Solutions

Uninterruptible Power Supply

www.deltapowersolutions.com



Delta Group

Leading expert in power management and thermal management solutions

Delta Group is the world's leading provider of power management and thermal management solutions, as well as a major source for components, visual displays, industrial automation, networking products, and renewable energy solutions. Delta Group is focused on three main businesses: power electronics, energy management, and smart green life. Delta Group has sales offices worldwide and manufacturing plants in Taiwan, China, Thailand, Japan, Mexico, India, Brazil and Europe.

As a global leader in power electronics, Delta's mission is, "To provide innovative, clean and energy-efficient solutions for a better tomorrow." Delta is committed to environmental protection and has implemented green, lead-free production and recycling and waste management programs for many years.

World no. 1 in Switching Power Supplies, DC Brushless Fans and Telecom Power Systems

163 sales offices and **39** manufacturing facilities worldwide

5-6% of annual sales revenues invested in R&D with over **7,000** engineers in **64** R&D centers worldwide

Awarded **7,100+** patents and received **47** internationally recognized design awards including iF, Reddot, and the Taiwan Excellence awards.

No. 1 supplier of merchant power supplies

According to the IHS report, Delta Electronics remained the largest supplier of merchant power supplies with an estimated market share of 15.5% in 2016 of a global market value that was estimated to be \$21,869 M.

Total Merchant Power Supply Market 2016 \$M Revenue		
Ranking	Company Name	Market Share
1	Delta Electronics	15.5%
2	Axxxxxn	7.5%
3	Lxxxxxx Technology	4.5%

Source: IHS report, AC-DC & DC-DC Merchant Power Supplies - 2017

Global Footprint

	Asia-Pacific (China)	Americas	EMEA	Total
Sales Offices	104 (61)	20	39	163
Plant Sites	32 (19)	4	3	39
R&D Centers	43 (23)	7	12	64

- Sales Offices
- Plant Sites
- R&D Centers



Awards

Delta Electronics outperformed 37 leading global companies in the Electronic Equipment, Instrument, and Component sector of the 2017 Dow Jones Sustainability Indexes (DJSI), and was selected for the DJSI World Index for the seventh consecutive year.



2007 - 2008
Forbes Asia's
Fabulous 50



2009
Frost & Sullivan Green
Excellence Award for
Corporate Leadership



2014
CPLI Climate Performance
Leadership Index, CPLI

MEMBER OF

**Dow Jones
Sustainability Indexes**

In Collaboration with RobecoSAM

2011 - 2017
Dow Jones
Sustainability Indexes

More information about Delta Group can be found at <http://www.deltaww.com/>

About Data Center Solutions

Our mission is realized by providing highly reliable and efficient power management products, including UPS and data center infrastructure solutions that ensure the continuity of mission critical operations and better total cost of ownership (TCO).



InfraSuite Manager

Have the entire data center at your fingertips!

- InfraSuite Manager integrates all facilities and IT equipment on one platform.
- It is a fully featured DCIM solution to deliver automation and visibility into the data center and increase the ease of management.

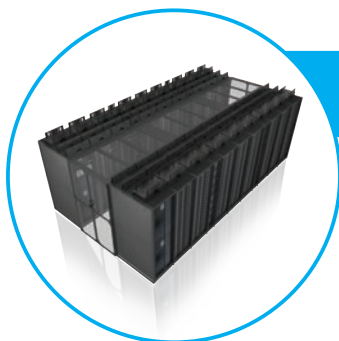
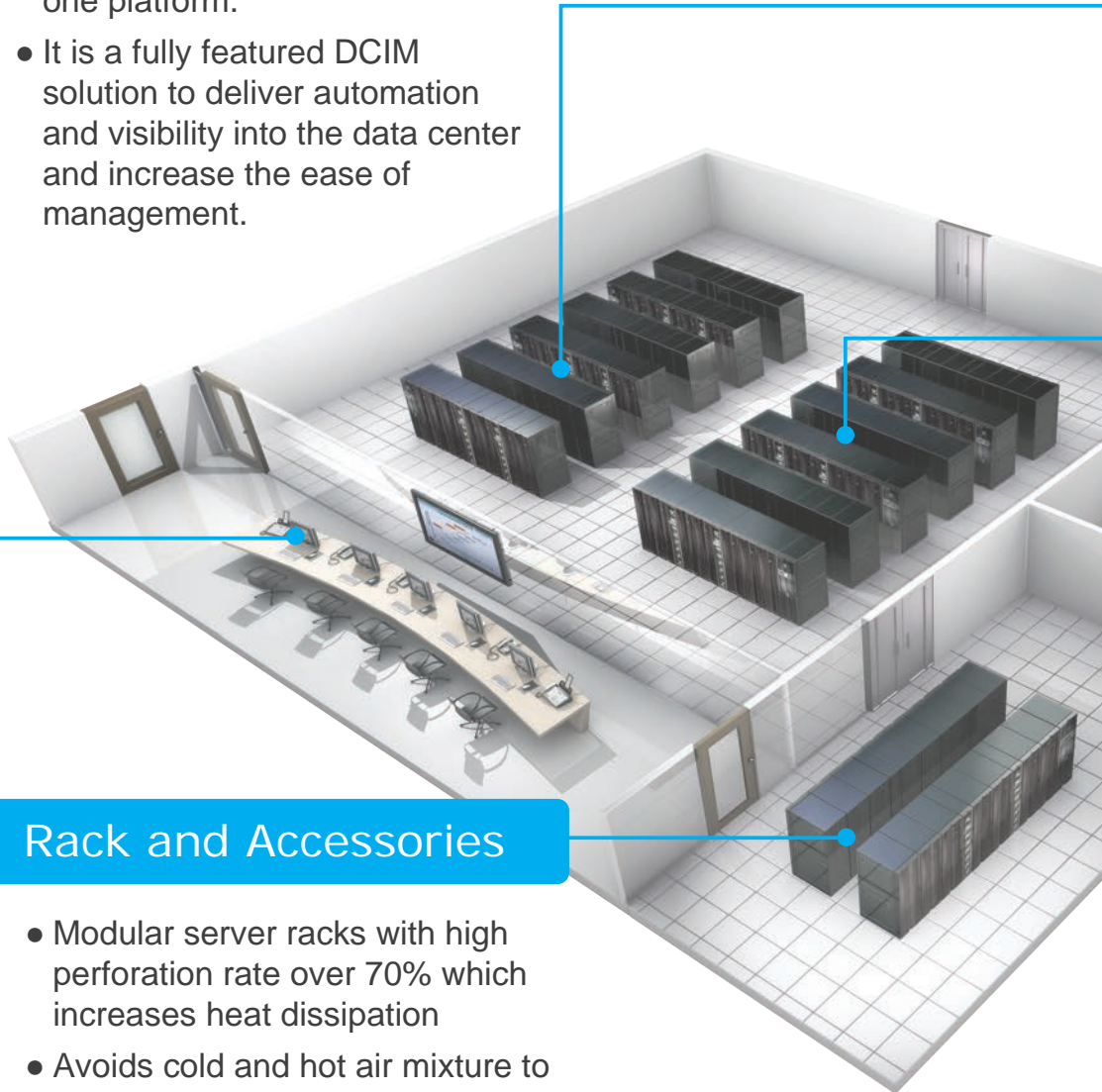

Rack and Accessories

- Modular server racks with high perforation rate over 70% which increases heat dissipation
- Avoids cold and hot air mixture to significantly improve PUE < 1.5



Data Center Service



POD



Prefabricated Data Center



Power Container



DCIM



Cooling



AC Power



Converged Power



Precision Cooling

- Highly-efficient variable fan speed control saves 27% of power if fan speed reduced by 10%



Power Distribution System

- PDU/RPP : Modular and hot-swappable output breakers
- rPDU : Reliable branch circuit breaker protection
- rRPP : Ideal power distribution solution to small data centers
- Busway : Safe and reliable power distribution solution



UPS System

- Fully modular design. Hot-scalable and hot-swappable
- Ultra-integrated system with power supply, power distribution and runtime
- Output PF up to 1
- Leading power efficiency up to 96.5%

Delta UPS

Our clients are most concerned about power issues such as power failure, power sag, power surge, under voltage or over voltage, frequency variation, harmonic distortion and line noise. Delta Electronics emphasizes the areas of redundant power supply, voltage regulation, equipment protection and adjustment and has designed and developed three UPS product families - Amplon, Ultron and Modulon. Their power range, applications and the equipment they protect are listed below:

Product Family	Power	Topology	Applications
Agilon	Under 1.5kVA	Single-Phase UPS	PC and Peripherals
Amplon	1kVA or higher	Single-Phase UPS	Server and Network Equipment
Ultron	10kVA or higher	Three-Phase On-Line UPS	Data center and Industrial Equipment
Modulon	20kVA or higher	Three-Phase Modular On-Line UPS	Modular unit expansion and redundant power supply can be achieved within a single rack.

Delta UPS systems feature the following:

- Leading AC-AC Efficiency
- Fully redundant design and configuration
- High input and output power factors
- Easy expansion without additional hardware
- Supports to seamless operations at low level of TCO (Total Cost of Ownership)



Product Application Matrix

	Agilon		Amplon				
	VX Series 0.6-1.5 kVA (line-interactive)	MX Series 1.1-3 kVA (line-interactive)	N Series 1-3 kVA (on-line)	N Series 6-10 kVA (on-line)	R Series 1-3 kVA (on-line)	RT Series 1-3 kVA (on-line)	RT Series 5-20 kVA (on-line)
Configuration 1:1	O	O	O	O	O	O	O
Configuration 3:1							O (15/20 kVA)
Configuration 3:3							O (15/20 kVA)
Rack mountable		O				O	O
Stand-alone	O	O	O	O	O	O	O
Isolation transformer				O			
Battery '	I	I,E	I, E	I, E	E	I, E	E
Home and office *	O	O	O			O	
Small enterprise, IT and medical **		O	O	O	O	O	O
Medium enterprise, telecom, IT, media ***				O			O
Heavy industry, telecom, IT, Industrial ****							
	Ultron				Modulon		
	EH Series 10-20 kVA (on-line)	HPH Series 20-200 kVA (on-line)	NT Series 20-500 kVA (on-line)	DPS Series 160-500 kVA 500-1200 kVA (on-line)	DPM Series 500-1375 kVA (on-line)	NH Plus Series 20-120 kVA (on-line)	DPH Series 25-200 kVA 50-500 kVA (on-line)
Configuration 1:1							
Configuration 3:1	O		O				
Configuration 3:3		O	O	O	O	O	O
Rack mountable							
Stand-alone	O	O	O	O	O		
Modular						O	O
Isolation transformer			O	O			
Battery '	E	I (BN/B), E	E	E	E	E	I (75K), E
Home and office *							
Small enterprise, IT and medical **	O	O	O	O			O
Medium enterprise, telecom, IT, media ***	O	O	O	O	O	O	O
Heavy industry, telecom, IT, Industrial ****	O	O	O	O	O	O	

'I': internal battery, E: external battery

* PCs, laptops, modems, printers, WiFi and audio equipment

** Computers, servers, networking, medical control and diagnostics, education, banking, industrial automation

*** Telecom base stations, data centers, backbone networks, broadcasting, projection systems

**** Telecom centers, data centers, medical equipment at hospitals, government use, automatic control, oil, gas and power utilities, industrial equipment, automation and control

Known for our quality

Delta's manufacturing across the globe

The Delta Group's operations are global in scale with 38 manufacturing facilities in Taiwan, China, Thailand, India, Mexico, Brazil and Slovakia. We also have 61 R&D centers across the globe and 153 sales offices on all 5 continents.



Delta's quality

Pursuing the highest quality and reliability of our products has been our primary target since Day 1. Every year Delta's manufacturing sites receive numerous awards and recognition as well as encouragement from our partners and clients, such as Dell, HPQ, IBM, Intel, Microsoft, NEC, GE, Sony and so on. Their continued partnerships and the awards received are the best demonstration of our emphasis on product quality.

All of our factories have received ISO 9001 and ISO 14001 international certificates which verify that our production conforms to the corresponding quality standards and evaluation. "Do things right the first time" is the belief that we always insist upon. Delta continues to provide the best quality control in terms of product development and manufacturing with our primary goal of satisfying our customers.

 <p>2010 HUAWEI Technical Support Award</p>	 <p>2011 SONY VAIO Remarkable Supply Performance</p>	 <p>2016 Lenovo Excellent Supplier Award</p>	 <p>2012 Texas Instruments Continued Partnership</p>	 <p>2014 CISCO OEM/ODM Partner of the Year</p>
 <p>2013 SHARP Best Supplier Award</p>	 <p>2013 Rockwell Automation Market Supplier of the Year</p>	 <p>2013 WKK Best Supplier of the Year</p>	 <p>2015 Panasonic Long-Term Support Appreciation</p>	 <p>2016 EPSON Excellent Partner and Good Quality</p>

Accredited laboratory

Delta's outstanding product design capability comes from our R&D team and its various precision measurement instruments. Our R&D centers utilize diverse advanced equipment and programs including CAD to facilitate circuit simulation, mechanical design, and PCB layout. Delta has nine well-equipped laboratories to conduct environment-related substance analysis, precision measurement, failure analysis, soldering techniques, electromagnetic compatibility and interference tests, material chemical analysis, quality engineering, safety tests, and more. In addition, we also have laboratories with controlled temperature and humidity to perform with numerous reliability tests.



ORT (Ongoing reliability test)

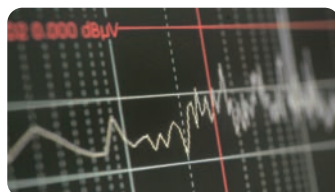

EMC / EMI (electromagnetic compatibility & interference)

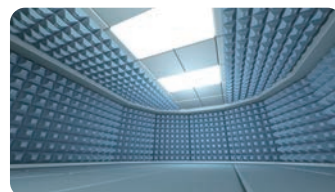

Acoustic test



Pulse lightning discharge

Why Delta UPS?



Quality

- Delta's large-scale production follows comprehensive quality management to do things right the first time and deliver the best quality
- All manufacturing sites are certified with ISO 9001 and ISO 14001 and conform to the highest quality control in terms of product development and production to achieve customer satisfaction.
- With six laboratories accredited by the China National Accreditation Service for Conformity Assessment (CNAS) all of our products go through the tightest checks.



Performance

- Wide input voltage range reduces the chance of battery use and extends battery life
- High input power factor increases utilization of utilities and reduces total cost
- High output power factor provides more real power to critical loads
- Higher efficiency lowers operating costs
- Lower harmonic distortion saves on upstream investment
- Compact design saves more space for critical equipment



Service

- 2-year warranty
- Service line is available on work days to answer your questions
- Customer-needs-oriented, available with comprehensive and professional service and technical support

Protect Your Critical Operati



Poland

The Delta UPS safeguards one of the largest fixed line operators



Russia

Delta's UPS protects one of Russia's most advanced medical healthcare centers



U.K.

The Delta UPS safeguards one of the largest fixed line operators



Germany

One of the major railway upgrade projects chose Delta UPS to secure their operations



Spain

The Delta UPS provides continuous power to one of the largest telecom operators



Brazil

A world-leading consumer goods manufacturer in Brazil uses Delta's UPS to secure their production



Angola

Delta's UPS ensures operations for one of Angola's largest data centers



South Africa

One of the major governmental data centers in South Africa chose Delta's UPS to secure their operations

ions 24/7



Russia

The Delta UPS secures power to the most advanced data centers in Russia



South Korea

The immigration office in the airport in Seoul uses Delta's UPS in their data centers



China

The InfraSuite Data Center Solution ensures the continuous operations of China's most modern TV tower

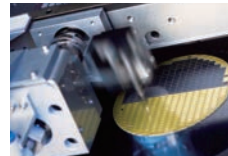

Taiwan

Delta's UPS and Precision Cooling products protect the leading semiconductor foundry in Taiwan



Taiwan

The infraSuite Data Center Solution safeguards the datacenter of a major university in Taiwan



India

A leading manufacturer of consumer packaging solutions uses Delta's UPS to secure stable power supply



Australia

The Delta UPS powers a major water utility in Australia



Thailand

The Delta UPS safeguards a large city monitoring operators in Thailand

Delta UPS – Agilon Family



Applicable Sectors



PC



Monitor



POS



ADSL



Home

VX Series, Line-interactive 600/1000/1500VA

The Agilon VX line-interactive UPS designed with microprocessor control offers reliable and cost-effective power protection for PCs, monitor, POS, and other sensitive electronics used in home offices and small businesses. The integrated Automatic Voltage Regulation (AVR) ensures all electronics are receiving stable power while providing higher availability. The Agilon VX series' LCD display, auto-shutdown software and other superior features make these units perfect for your data protection.

Features:

- The integrated AVR (Automatic Voltage Regulation) stabilizes the output voltage for better power quality
- Excellent microprocessor control enables accurate detection of power frequency for higher reliability
- Wide input voltage range allows the UPS to work in harsh electrical environments and reduces battery discharging time
- Batteries are automatically recharged even when the UPS is in off mode and the UPS can start without mains (Cold-Start)
- UPS is able to restart automatically while utility power is recovering
- Surge protection defends your critical load against damage
- Supplied with IEC output power cable for convenient connection to your load
- Several standard IEC 320 output sockets simplify the connectivity to computer and IT peripherals
- Compact size saves more space for critical equipment
- Standard USB communication port enhances monitoring and manageability
- Touch screen LCD for a clear display of UPS information
- Advanced UPS management software provides remote shutdown and control

The above features are for EMEA models.

Technical Specification

Model		VX-600VA	VX-1000VA	VX-1500VA
Power Rating		600VA/360W	1000VA/600W	1500VA/900W
Input	Nominal Voltage	230 Vac		
	Voltage Range	170 ~ 280 Vac (full load)		
	Frequency Range	45 ~ 65 Hz		
Output	Voltage	230 Vac ± 10% (Battery mode)		
	Frequency Range	50/60 Hz ± 1 Hz		
	Waveform (Batt. Mode)	Simulated Sinewave		
	Receptacle	IEC 320 C13 x 4	IEC 320 C13 x 4	IEC 320 C13 x 6
Battery	Battery Type & Number	12V/7 Ah x 1	12V/7 Ah x 2	12V/9 Ah x 2
	Recharge Time	6 ~ 8 hours to 90%		
	Cold Start	Yes		
Indicator		LCD		
Communication Interfaces	Standard	USB Port x 1		
Environment	Operating Temperature	0 ~ 40°C		
	Altitude	0 ~ 1000m		
	Relative Humidity	0 ~ 95% (non-condensing)		
Audible Noise		< 40 dB		< 45 dB
Conformance	Safety	CE		
Physical	Dimensions (W x D x H)	101 x 279 x 142 mm	130 x 320 x 182 mm	
	Net Weight	4.4 kg	8.2 kg	10.4 kg

The above specifications are for EMEA models.

All specifications are subject to change without prior notice.



2007~ 2008 Forbes Asia's Fabulous 50



2009 Frost & Sullivan Green Excellence Award for Corporate Leadership



Delta's Manufacturing System is Certified by ISO 9001 and ISO 14001 Standards



IECQ Certificate of Hazardous Substance Process Management



Delta UPS - Amplon Family



Applicable Sectors



School



Infrastructure



SME



POS



Banking



Retail

MX Series, Line-interactive 1.1/2/3 kVA

The Amplon MX line-interactive UPS provides pure sine-wave quality compatibility in versatile application in order to protect devices and prevent small-and-medium businesses from power failure and voltage variations in small footprint. The Amplon MX series features enhanced output power factor 0.9, AVR Efficiency up to 96.5%, resulting in a greater power supply for critical loads at significantly less operating cost.

Features:

- Microprocessor-based line interactive design for fast response to power disturbances
- Programmable load bank disconnects non-critical loads when a blackout occurs and reserves more battery power for critical loads
- Automatic voltage regulator (AVR) delivers stable output voltage during brownouts or over-voltages
- Wide input voltage range allows the UPS to work in harsh electrical environments
- Hot-swappable battery design to protect equipment during battery replacement
- Supports both rack and tower installation
- Excellent management through a user-friendly graphical and easy-shift LCD display to suit different installation format
- Supports multiple communication interfaces, including USB port, RS-232, Mini Slot, Surge Protection, REPO for enhanced monitoring and manageability
- Output power factor is up to 0.9 to provide more real power to critical loads
- High efficiency normal mode reach at 98% and 98.5% for 3kVA
- Wide input range and protection against over voltage prolongs battery life

Technical Specification

Model		MX-1.1K	MX-2K	MX-3K
Power Rating		1100VA / 990W	2000VA / 1800W	3000VA / 2700W
Input	Voltage Range	200V: 150-234V / 208V: 156-243V / 220V: 162-268V 230V: 170-280V / 240V: 177-290V		
	Nominal Frequency	50/60 Hz (Auto-Detection)		
	Connection	IEC C14	IEC C20	
	Phase	Single phase with ground		
Output	Voltage	200 / 208 / 220 / 230 / 240 Vac		
	Voltage Regulation	±1.5% (Batt. Mode)		
	Frequency Range (Batt. Mode)	50 Hz or 60 Hz ± 1 Hz		
	Connection	IEC C13 (4+4)	IEC C13 (4+4) IEC C19 (1)	
	Overload	103% ~ 120%: 5 minutes (1 minute @ Battery mode), 120% ~ 150%: 10 seconds, >150%: UPS shutdown immediately		
	Current Crest Ratio	3:1		
	Harmonic Distortion	Linear load (full load) ≤2%, Non-linear load (full load) ≤5%		
	Waveform (Batt. Mode)	Pure Sinewave		
Battery	Battery Type	12V/9Ah Sealed lead-acid battery		
	Numbers	2	4	6
	Recharge Time	4 hours recover to 90% capacity		
Interface	Standard	RS-232 Port x 1, USB Port x 1, MINI Slot x 1, Surge Protection, REPO		
Efficiency	Normal Mode	98%		98.5%
	AVR Mode	96.5%	96.5%	
Environment	Operating Temperature	0 ~ 40°C		
	Relative Humidity	20 ~ 90 % RH (non-condensing)		
	Noise Level	< 45 dBA	< 45 dBA @ Normal mode, < 55 dBA @ Battery mode	
Physical	Dimensions (W x D x H)	438 x 410 x 88 mm	438 x 510 x 88 mm	438 x 630 x 88 mm
	Net Weight (kg)	14.1	21.3	32.1

All specifications are subject to change without prior notice.



2007 ~ 2008 Forbes Asia's
Fabulous 50



2009 Frost & Sullivan
Green Excellence Award for
Corporate Leadership



Delta's Manufacturing
System is Certified by
ISO 9001 and ISO 14001
Standards



IECQ Certificate of
Hazardous Substance
Process Management



Delta UPS - Amplon Family

N Series, Single Phase 1/2/3 kVA



The Amplon N series is a true online double-conversion UPS that can provide your critical equipment with reliable, stable sine wave power. It features significant advantages, including an output power factor of 0.9 and up to 93% AC-AC efficiency for greater energy savings. The Amplon N series provides a safe power supply guaranteed for mission critical applications such as work stations, POS, ATMs, servers, and more.

Features:

- True online double-conversion topology and zero transfer time to battery ensure high reliability
- Advanced DSP (Digital Signal Processor) controller for fast computation capability and a simplified control circuit for enhanced stability
- Wide input voltage range allows the UPS to work in harsh electrical environments
- Generator compatibility ensures continuous and reliable power
- High input power factor (> 0.99) and low input harmonic distortion (iTHD < 3%) save upstream investment
- Output power factor up to 0.9 presents a stronger load capacity
- AC-AC efficiency up to 93% and high efficiency of 91% at 50% load results in marked energy cost savings
- Compact design saves more space for critical equipment
- Excellent local communications through LCD display
- Intelligent battery management maximizes battery performance and sustains battery life
- Mini slot and USB port enhance monitoring and manageability

Applicable Sectors



Server



Network



POS



Banking

Technical Specification

Model		N-1K	N-2K	N-3K
Power Rating		1kVA/0.9kW	2kVA/1.8kW	3kVA/2.7kW
Input	Nominal Voltage	220/230/240 Vac		
	Voltage range	175 ~ 280 Vac (full load); 80 ~ 175 Vac (50 ~ 100% load)		
	Frequency	40 ~ 70 Hz		
	Power Factor	> 0.99 (full load)		
	Current Harmonic Distortion	< 3%		
Output	Power Factor	0.9		
	Voltage	220/230/240 Vac		
	Frequency	50/60 Hz ± 0.05 Hz		
	Voltage Harmonic Distortion	< 3% (linear load)		
	Overload Capability	< 105%: continuous; 105 ~ 125%: 1 minute; 125 ~ 150%: 30 seconds		
	Receptacle	IEC C13 x 4	IEC C13 x 6, C19 x 1	
Efficiency	AC-AC	91%	Up to 93%	
Battery	Battery Voltage	24 Vdc	48 Vdc	72 Vdc
	Typical Backup Time	4.5 minutes (full load); 13 minutes (half load)		
	Recharge Time	3 hours to 90%		
	Charge Current	1.5A		
Audible Noise		< 43 dB	< 48 dB	
Display		LCD panel		
Communication Interfaces		MINI Slot x 1, USB Port x 1		
Conformance	Safety	CE, RCM, KC		
Physical	Dimensions (Wx Dx H)	145 x 320 x 225 mm	190 x 390 x 325 mm	
	Weight	9 kg	18.6 kg	24.4 kg
Environment	Operating Temperature	0 ~ 40° C		
	Relative Humidity	0 ~ 95% (no condensing)		

The above specifications are for SEA & EMEA models.

All specifications are subject to change without prior notice.



2007–2008 Forbes Asia's Fabulous 50



2009 Frost & Sullivan Green Excellence Award for Corporate Leadership



Delta's Manufacturing System is Certified by ISO 9001 and ISO 14001 Standards



IECQ Certificate of Hazardous Substance Process Management



Delta UPS - Amplon Family



Applicable Sectors



Server



Network



Security



Telecom



POS



Banking

N Series, Single Phase 6/10 kVA

The Amplon N series 6-10kVA UPS is a single-phase on-line UPS with pioneering technology that provides output power factor up to unity and AC-AC efficiency to a maximum 95%. Its remarkably compact dimensions reserve more room for critical equipment such as workstations, POSs, ATMs, office appliances, small server rooms, and production equipment. The Amplon N series superior features include a N+X parallel redundancy function and variable fan speed control to guarantee high system availability and best Total Cost of Ownership (TCO).

Features:

- The smallest dimensions in its class saves significant space for more critical equipment
- A pioneer in unity power factor (kVA=kW) to maximize power availability
- The highest AC-AC efficiency up to 95% and efficiency of 98% in ECO mode for exceptional energy cost savings
- Automatic speed regulation function with multi-stage fan speed control to maximize system efficiency, significantly reduce audible noise, and prolong the service life of the fans
- True online double-conversion topology and zero transfer time to battery to ensure high reliability
- Parallel configuration for expansion and N+X redundancy up to 4 units
- Advanced DSP (Digital Signal Processor) controller for fast computation capabilities and a simplified control circuit for enhanced stability
- Generator compatibility to ensure continuous and reliable power
- Excellent local communications through user-friendly LCD display and LED indicators
- Intelligent battery management to maximize battery performance and extend battery life
- Various types of communication interfaces for monitoring and manageability

Technical Specification

Model		N-6K	N-10K
Power Rating		6kVA/6kW	10kVA/10kW
Input	Nominal Voltage	200/208/220/230/240 Vac	
	Voltage Range	200/208 (de-rating to 90%) : 100 Vac ~ 280 Vac* 220/230/240 : 100 Vac ~ 280 Vac**	
	Frequency	40 Hz ~ 70 Hz	
	Power Factor	> 0.99 (full load)	
	Current Harmonic Distortion	< 3%	
Output	Power Factor	1	
	Nominal Voltage	200/208/220/230/240 Vac	
	Frequency	50/60 Hz ±0.05 Hz	
	Voltage Harmonic Distortion	< 2% (linear load)	
	Overload capability	< 105%: continuous; 105 ~ 125%: 2 minutes; 125 ~ 150%: 30 seconds	
Efficiency	AC-AC	Up to 95%	
	ECO mode	Up to 98%	
Battery	Battery Voltage	192 ~ 264 Vdc adjustable	
	Charge current	1.5 ~ 8A selectable	
Audible Noise		< 50 dB	
Display		LED indicators and LCD display	
Communication Interfaces		REPO x 1, RS-232 Port x1, USB Port x1, Parallel Port x 2, Smart Slot x 1	
Physical	Dimensions (W x D x H)	190 x 390 x 325 mm	
	Weight	10.1 kg	12.7 kg
Environment	Operating Altitude	1000 meters (without de-rating)	
	Operating Temperature	0 ~ 40°C (at 100% load) 45 ~ 55°C (de-rating to 80%)	
	Relative Humidity	5 ~ 95% (non-condensing)	

Note:

* Linear de-rating between 40 ~ 90% load at 100 ~ 175Vac.

**Linear de-rating between 40 ~ 100% load at 100 ~ 194Vac.

The above specifications are for SEA models.

All specifications are subject to change without prior notice.



2007~ 2008 Forbes Asia's Fabulous 50



2009 Frost & Sullivan Green Excellence Award for Corporate Leadership



Delta's Manufacturing System is Certified by ISO 9001 and ISO 14001 Standards



IECQ Certificate of Hazardous Substance Process Management



Delta UPS - Amplon Family

R Series, Single Phase 1/2/3 kVA (Standard Runtime Model)



Applicable Sectors



Server



Telecom



Industrial



VoIP



Storage



Network

Delta's Amplon R series is an online double-conversion rack-mountable UPS providing consistent sine-wave power to your critical equipment and reliable protection for IT equipment and data centers. The R series offers an output power factor of 0.9 and a best-in-class AC-AC efficiency of up to 93% for greater energy savings. The Amplon R series leads the industry in combining compact size, availability, flexibility, and low total cost of ownership.

Features:

- True online double-conversion topology provides zero transfer time to ensure maximum protection of the equipment
- Watch-dog design of the DSP (Digital Signal Processor) increases reliability
- Cold-start capability provides temporary battery power when the utility power is out
- Operating temperature tolerance up to 50°C ensures critical loads' continuity
- The Maintenance Bypass Box offers load continuity during battery replacement or other upgrades
- Compact dimensions meet the needs of different rack cabinets
- Convertible rack and tower configuration in 2U size cabinet
- Excellent local communications through rotatable LCD display
- Intelligent management software connectivity via RS232, mini slot or USB port
- Wide input voltage range reduces the chance of using the battery and extends battery life
- Intelligent battery management sustains battery life and performance
- High output power factor 0.9 provides more real power to critical loads
- High input power factor (pf > 0.99) and low harmonic distortion (iTHD < 3%) save upstream investment
- Up to 93% AC-AC efficiency and 96% efficiency in ECO mode results in marked energy cost savings
- Fan speed control by load level and room temperature optimizes performance

Technical Specification

Model		R-1K	R-2K	R-3K
Power Rating		1kVA/0.9kW	2kVA/1.8kW	3kVA/2.7kW
Input	Nominal Voltage	200*/208*/220/230/240 Vac		
	Voltage Range	175 ~ 280 Vac (full load); 80 ~ 175 Vac (50 ~ 100% load)		
	Frequency	40 ~ 70 Hz		
	Power Factor	> 0.99 (full load)		
	Current Harmonic Distortion	< 3%		
Output	Power Factor	0.9		
	Voltage	200*/208*/220/230/240 Vac		
	Voltage Regulation	± 1% (linear load)		
	Frequency	50/60 Hz ± 0.05 Hz		
	Voltage Harmonic Distortion	< 3% (linear load)		
	Overload Capability	< 105%: continuous; 105 ~ 125%: 1 minute; 125 ~ 150%: 30 seconds		
	Receptacle	IEC C13 x 4 Brazil Socket x 3 Argentina Socket x 3	IEC C13 x 6, C19 x 1 Brazil Socket x 4 Argentina Socket x 4	IEC C13 x 6, C19 x 1 Brazil Socket x 4 Argentina Socket x 4
Efficiency	AC-AC	91%	Up to 93%	
	ECO Mode	95%	Up to 96%	
Battery	Battery Voltage	24 Vdc	48 Vdc	72 Vdc
	Typical Backup Time*	6.5 minutes	7 minutes	7 minutes
	Charge Current	1.5A		
	Recharge Time	3 hours to 90%		
Audible Noise**		< 40 dB	< 43 dB	< 43 dB
Display		LCD display and LED indicators		
Communication Interfaces	Standard	Mini Slot x 1, RS-232 Port x 1, USB Port x 1		
Conformance	Safety	CE		
Dimensions (W x D x H)	UPS	440 x 335 x 88 mm	440 x 430 x 88 mm	440 x 565 x 88 mm
	External Battery Pack	440 x 335 x 88 mm	440 x 430 x 88 mm	440 x 565 x 88 mm
Weight	UPS	11.5 kg	20.6 kg	27.5 kg
	External Battery Pack	18.8 kg	30.3 kg	54.1 kg
Environment	Operating Temperature	0 ~ 50°C***		
	Relative Humidity	5 ~ 95% (non-condensing)		

* When the UPS is de-rated to 90% of its capacity.

** If the UPS is running at < 75% load and in room temperature.

*** When the operating temperature is at 40 ~ 50°C, the UPS will be de-rated to 80% of its capacity.

The above specifications are for SA models.

All specifications are subject to change without prior notice.



2007~ 2008 Forbes Asia's Fabulous 50



2009 Frost & Sullivan Green Excellence Award for Corporate Leadership



Delta's Manufacturing System is Certified by ISO 9001 and ISO 14001 Standards



IECQ Certificate of Hazardous Substance Process Management



Delta UPS - Amplon Family



Applicable Sectors



Server



Telecom



Industrial



VoIP



Storage



Network

R Series, Single Phase 1/2/3 kVA (Extended Runtime Model)

Delta's Amplon R series is an online double-conversion rack-mountable UPS providing consistent sine-wave power to your critical equipment and reliable protection for IT equipment and data centers. The R series offers an output power factor of 0.9 and a best-in-class AC-AC efficiency of up to 93% for greater energy savings. The Amplon R series leads the industry in combining compact size, availability, flexibility, and low total cost of ownership.

Features:

- True online double-conversion topology provides zero transfer time to ensure maximum protection of the equipment
- Watch-dog design of the DSP (Digital Signal Processor) increases reliability
- Cold-start capability provides temporary battery power when the utility power is out
- Operating temperature tolerance up to 50°C ensures critical loads' continuity
- The Maintenance Bypass Box offers load continuity during battery replacement or other upgrades
- Compact dimensions meet the needs of different rack cabinets
- Convertible rack and tower configuration in 2U size cabinet
- Excellent local communications through rotatable LCD display
- Intelligent management software connectivity via RS232, mini slot or USB port
- Wide input voltage range reduces the chance of using the battery and extends battery life
- Intelligent battery management sustains battery life and performance
- High output power factor 0.9 provides more real power to critical loads
- High input power factor (pf > 0.99) and low harmonic distortion (iTHD < 3%) save upstream investment
- Up to 93% AC-AC efficiency and 96% efficiency in ECO mode results in marked energy cost savings
- Fan speed control by load level and room temperature optimizes performance
- Optional charger up to 8A for long backup application

Technical Specification

Model		R-1K	R-2K	R-3K
Power Rating		1kVA/0.9kW	2kVA/1.8kW	3kVA/2.7kW
Input	Nominal Voltage	200*/208*/220/230/240 Vac		
	Voltage Range	175 ~ 280 Vac (full load) ; 80 ~ 175 Vac (50 ~ 100% load)		
	Frequency	40 ~ 70 Hz		
	Power Factor	> 0.99 (full load)		
	Current Harmonic Distortion	< 3%		
Output	Power Factor	0.9		
	Voltage	200*/208*/220/230/240 Vac		
	Voltage Regulation	± 1% (linear load)		
	Frequency	50/60 Hz ± 0.05 Hz		
	Voltage Harmonic Distortion	< 3% (linear load)		
	Overload Capability	< 105%: Continuous; 105 ~ 125%: 1 minute; 125 ~ 150%: 30 seconds		
	Receptacle	IEC C13 x 4	IEC C13 x 6 IEC C19 x 1	IEC C13 x 6 Terminal
Efficiency	AC-AC	91%	Up to 93%	
	ECO Mode	95%	Up to 96%	
Battery	Battery Voltage	24 Vdc	48 Vdc	72 Vdc
	Charge Current	4A (up to 8A with optional inbuilt charger)		
Audible Noise**		< 40 dB	< 43 dB	< 43 dB
Display		LCD display and LED indicators		
Communication Interfaces	Standard	Mini Slot x 1, RS-232 Port x 1, USB Port x 1		
Conformance	Safety	CE, RCM, TISI, BIS		
Physical	Dimensions (Wx Dx H)	440 x 335 x 88 mm	440 x 430 x 88 mm	440 x 430 x 88 mm
	Weight	5.3 kg	9.0 kg	9.1 kg
Environment	Operating Temperature	0 ~ 50°C***		
	Relative Humidity	5 ~ 95% (non-condensing)		

* When the UPS is de-rated to 90% of its capacity.

** If the UPS is running at < 75% load and in room temperature.

*** When the operating temperature is at 40 ~ 50°C, the UPS will be de-rated to 80% of its capacity.

The above specifications are for EMEA models.

All specifications are subject to change without prior notice.



2007~ 2008 Forbes Asia's Fabulous 50



2009 Frost & Sullivan Green Excellence Award for Corporate Leadership



Delta's Manufacturing System is Certified by ISO 9001 and ISO 14001 Standards



IECQ Certificate of Hazardous Substance Process Management



Delta UPS - Amplon Family



Applicable Sectors



Server



Telecom



Industrial



Network



VoIP



Storage



Medical

RT Series, Single Phase 1/2/3 kVA

The Amplon RT 1-3kVA series is an online double-conversion UPS providing consistent sine-wave power to your critical equipment. It supports personal computers, networks, servers, VoIP and telecommunications. RT 1-3kVA series features an output power factor of 0.9 and best-in-class AC-AC efficiency up to 94% resulting in greater energy savings. Optional external battery pack can be connected for longer backup time to keep your applications safe and running smoothly at all times.

Features:

- True online double-conversion topology and zero transfer time to battery ensure high reliability
- Watch-dog design of DSP (Digital Signal Processor) increases reliability
- Cold-start capability provides temporary battery power when the utility power is out
- Fan failure detection alerts users to failed fans
- Hot swappable batteries ensure continuous operation even when batteries are being replaced
- Optional external battery pack for easy scaling of longer backup time
- High output power factor 0.9 provides more real power to critical loads
- High input power factor (pf > 0.99) and low harmonic distortion (iTHD < 5%) save upstream investment
- Up to 94% AC-AC efficiency and 97% efficiency in ECO mode result in marked energy cost savings
- Wide input voltage range reduces the chance of using the battery and extends battery life
- Intelligent battery management sustains battery life and performance
- Fan speed control by load level maximizes efficiency and reduces audible noise
- Load segment control allows less-critical loads to be disconnected during blackouts and saves battery runtime for important loads
- Convertible rack and tower configuration in 2U size cabinet
- Excellent local communications through rotatable LCD display
- Intelligent management software connectivity via RS232 or USB port

Technical Specification

Model		RT-1K	RT-2K	RT-3K
Power Rating		1kVA/0.9kW	2kVA/1.8kW	3kVA/2.7kW
Input	Nominal Voltage	200*/208*/220/230/240 Vac		
	Voltage range	175 ~ 280 Vac (full load); 120 ~ 175 Vac (70 ~ 100% load)		
	Frequency	40 ~ 70 Hz		
	Power Factor	> 0.99 (full load)		
	Current Harmonic Distortion	< 5%		
Output	Power Factor	0.9		
	Voltage	200*/208*/220/230/240 Vac		
	Voltage Regulation	± 1% (linear load)		
	Frequency	50/60 Hz ± 0.05 Hz		
	Voltage Harmonic Distortion	< 2% (linear load)		
	Overload Capability	< 105%: continuous; 105 ~ 125%: 1 minute; 125 ~ 150%: 15 seconds		
	Receptacle	IEC C13 x 6	IEC C13 x 6 IEC C19 x 1	IEC C13 x 6 IEC C19 x 1
Efficiency	Online Mode	90%	Up to 94%	
	ECO Mode	96%	Up to 97%	
Battery	Battery Voltage	24 Vdc	48 Vdc	72 Vdc
	Typical Backup Time**	6.5 minutes	7.5 minutes	
	Charge Current	1.5A	2A	2A
	Recharge Time	3 hours to 90%		
Audible Noise		< 40 dB	< 43 dB	< 46 dB
Display		LCD display and LED indicators		
Communication Interfaces		SMART Slot x 1, RS-232 Port x 1, USB Port x 1, REPO x 1		
Comformance		EN 62040-1, CE, TISI, RCM, EAC		
Dimensions (W x D x H)	UPS	440 x 335 x 89 mm	440 x 432 x 89 mm	440 x 610 x 89 mm
	External Battery Pack	440 x 335 x 89 mm	440 x 432 x 89 mm	440 x 610 x 89 mm
Weight	UPS	12 kg	18 kg	28 kg
	External Battery Pack	15 kg	27 kg	44 kg
Environment	Operating Temperature	0 ~ 50°C***		
	Relative Humidity	5 ~ 95% (non-condensing)		

* When the UPS is de-rated to 90% of its capacity.

** When the total load reaches 75%.

*** 40 ~ 50°C with 80% de-rating

All specifications are subject to change without prior notice.



2007-2008 Forbes Asia's Fabulous 50



2009 Frost & Sullivan Green Excellence Award for Corporate Leadership



Delta's Manufacturing System is Certified by ISO 9001 and ISO 14001 Standards



IECQ Certificate of Hazardous Substance Process Management



Delta UPS - Amplon Family



Applicable Sectors



Server



Network



Banking



Telecom



Data Center



Industrial

RT Series

5/6/8/10 kVA, Single Phase
15/20 kVA, Three Phase

The Amplon RT Series 5-20kVA is an online double-conversion UPS that provides best-in-class designs in compact 2U size, high power density, system efficiency, and versatile configurations to fulfill customers' requirements. RT Series 5-20kVA UPS is the first in the market that offers standard Li-ion external battery cabinets, which deliver better power density and sustainability. Along with the parallel capacity of up to four units, the new series is the ideal small power UPS for mission-critical applications, such as servers, data centers, telecommunications, and manufacturing.

Features:

- True online double-conversion topology and zero transfer time to battery provides 24/7 full-time protection
- Unity output power factor guarantees no de-rating with loads and provides permanent 100% kW
- Best-in-class AC-AC efficiency of up to 96.5% and 99% in ECO mode lowers energy costs
- Automatic fan speed control maximizes system efficiency and significantly reduces audible noise and prolongs battery life
- Fan failure detection sends early warnings to facilitate predictive maintenance of UPS
- Programmable load bank disconnects non-critical loads when a blackout occurs and reserves more battery power for critical loads
- Up to four units parallel capacity allows redundancy and load expansion
- Hot swappable batteries ensure continuous operation even when batteries are being replaced
- VRLA and Li-ion External Battery Cabinet (EBC) are available for scalable runtime
- The Maintenance Bypass Breaker (MBB) is optional for easy UPS replacement without powering down critical systems
- The rRPP (Rack Remote Power Panel), which can be integrated with standard server racks, simplifies power output distribution and power monitoring
- Common battery configuration is supported in UPS parallel mode to save installation space and additional battery costs

Technical Specification

Model		RT-5K	RT-6K	RT-8K	RT-10K	RT-15K3P	RT-20K3P
Power Rating		5kVA/5kW	6kVA/6kW	8kVA/8kW	10kVA/10kW	15kVA/15kW	20kVA/20kW
Input	Voltage Range	100 ~ 280V (Single phase, 2-wire + G) 100 ~ 175V with linear de-rating 50 ~ 100%				138 ~ 485V (Three phase, 4-wire + G) 138 ~ 305V with linear de-rating 40 ~ 100%	
	Frequency	40 ~ 70 Hz					
	Power Factor	> 0.99 (full load)					
	iTHD	< 3%					
	Input connection	Input terminal x 1				Input terminal x 1, Bypass Input terminal x 1	
Output	Power Factor	Unity					
	Voltage	200, 208, 220, 230, 240 Vac (Single phase)				380/400/415 Vac (Three phase), or 220/230/240 Vac (Single phase)	
	Frequency	50/60Hz ±0.05Hz					
	Voltage Harmonic Distortion	≤ 2% (linear load)					
	Overload Capability	≤ 105%: continuous; 106 ~ 125%, 5 min.; 126 ~ 150%, 1 min.; > 150%: 500ms				≤ 105%: continuous; 106 ~ 125%: 2 min.; 126 ~ 150%: 30 sec; > 150%: 200ms	
Receptacle	Standard Runtime Model	C13x6, C19x2, Terminal x 1 Load bank: C19x1		C13x6, C19x4, Terminal x 1 Load bank: C19x1		Terminal x 1	
	Extended Runtime Model	Terminal x 1 Load bank: Terminal x 1					
Efficiency	AC-AC	Up to 95.5%				Up to 96.5%	
	ECO Mode	Up to 99%					
Battery Voltage	Standard Runtime Model	192 Vdc	192 Vdc	240 Vdc	240 Vdc	±144 Vdc*, ±192 ~ 264 Vdc	
	Extended Runtime Model	144 Vdc*, 192 ~ 264 Vdc					
Charger Current	Standard Runtime Model	1A (default)		1.5A (default)		Up to 8A	
	Extended Runtime Model	Up to 8A					
Typical Backup Time (VRLA bat.)	Standard Runtime Model	75% load	7.5 min.	5.5 min.	9 min.	6 min.	Depending on different configurations required by customers
		Full load	5 min.	3 min.	5 min.	3.5 min.	
	Extended Runtime Model	Depending on different configurations required by customers					
Audible Noise		48 dB		50 dB		54 dB	
Display		Graphical and multi-lingual LCD					
Communication Interfaces		MINI Slot x 1, Parallel Port** x 2, USB Port x 1, RS232 Port*** x 1, RS485 Port x 1, REPO/ROO Port x 1, Dry Contact x 4					
Dimensions (W x D x H)	Standard Runtime Model	440 x 665 x 176 mm		440 x 750 x 218 mm		440 x 730 x 88.2 mm	
	Extended Runtime Model	440 x 430 x 88.2 mm		440 x 565 x 88.2 mm			
Weight	Standard Runtime Model	54 kg	54 kg	85.5 kg	85.5 kg	22 kg	22.5 kg
	Extended Runtime Model	10.9 kg	10.9 kg	15.2 kg	15.2 kg		
Environment	Operating Temperature	0 ~ 55° C****					
	Relative Humidity	5 ~ 95% (non-condensing)					

* De-rating to 70% load

** Only applicable to RT 5-10kVA Extended Runtime Model and RT 15/20kVA

*** Not applicable to RT 20kVA

**** When the operating temperature is at 40 ~ 55° C, the UPS will be de-rated to 75% of its capacity

All specifications are subject to change without prior notice.



2007 ~ 2008 Forbes Asia's Fabulous 50



2009 Frost & Sullivan Green Excellence Award for Corporate Leadership



Delta's Manufacturing System Certified by ISO 9001 and ISO 14001 Standards



IECO Certificate of Hazardous Substance Process Management



Delta UPS – Ultron Family



Applicable Sectors



Data Center



Telecom



Industrial



Network



Security



Lab



Medical



Metro



Banking



Retail

EH Series, Three Phase In - Single Phase Out 10/15/20 kVA

The Ultron EH series is an online double-conversion 3p-1p UPS which provides reliable power protection for IT rooms, telecommunications, banking, medical facilities and industry. Supported with DSP based technology, it offers rapid computation capabilities that enhance system stability and provide precise voltage to load. The Ultron EH series offers many superior features including N+X parallel redundancy and a built-in manual bypass switch to guarantee higher availability and reliability for protecting your critical loads.

Features:

- True online double-conversion technology to completely protect the critical load from problems occurring on the source side
- DSP based technology to support rapid computation capability and a simplified control circuit for enhanced stability
- Dual input design to allow different power supply sources for enhanced availability
- Built-in manual bypass ensures continuous power to the load during maintenance
- A wide input voltage range to reduce battery discharge probability and prolong battery life
- ECO mode efficiency up to 96% to reduce operating cost
- Small footprint to save space
- Parallel expansion and N+X redundancy up to 4 units without requiring additional hardware
- Additional internal charger and external charger box provide flexible capacity expansion
- Remote and local emergency power-off functions (EPO) to promptly manage the UPS when emergencies occur
- Multi-connectivity interface to support remote UPS monitoring and management
- Advanced management software to provide event alert management, remote shutdown, event log tracking and analysis
- Reliable battery management for better battery protection

Technical Specification

Model		EH-10K	EH-15K	EH-20K
Power Rating (kVA)		10	15	20
Power Rating (kW)		8	12	16
Input	Nominal Voltage	220/380 Vac, 230/400 Vac, 240/415 Vac		
	Voltage Range	208 ~ 304 Vac (50 ~ 100% load); 305 ~ 477 Vac (100% load)		
	Power Factor	> 0.95 (full load)		
	Frequency	45 ~ 65 Hz		
Output	Voltage	220/230/240 Vac		
	Voltage Harmonic Distortion	< 3% (linear load)		
	Voltage Regulation	± 2 %		
	Frequency	50/60 Hz ± 0.1Hz		
	Overload Capacity	≤105 %: continuous; 106 ~ 110%: 10 minutes; 111 ~ 125%: 1 minute; 126 ~ 150%: 30 seconds		
Battery	Battery Voltage	240 Vdc		
	Charge Current	Built-in: 4A Additional charger board (optional): 4A		
	Charge Voltage	Float charge 272 ± 2 Vdc Boost charge 280 Vdc		
Communication Interfaces		SMART Slot x 1, MINI Slot x 1, Parallel Port x 2, RS232 Port x 1, REPO Port x 1, Charger Detection Port x 1		
Conformance	Safety & EMC	CE, IEC62040-1, IEC62040-2		
Other Features	Emergency Power Off	Local and remote		
	Maintenance Bypass Switch	Built-in		
Efficiency	Online Mode	91%		
	ECO Mode	96%		
Environment	Operating Temperature	0 ~ 40 °C		
	Relative Humidity	5 ~ 95 % (non-condensing)		
	Audible Noise	< 55 dB	< 60 dB	
Physical	Dimensions (W x D x H)	200 x 490 x 490 mm	250 x 610 x 650 mm	
	Weight	26 kg	45 kg	

All specifications are subject to change without prior notice.

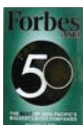

2007~ 2008 Forbes Asia's Fabulous 50



2009 Frost & Sullivan Green Excellence Award for Corporate Leadership



Delta's Manufacturing System is Certified by ISO 9001 and ISO 14001



IECQ Certificate of Hazardous Substance Process Management



Delta UPS – Ultron Family



HPH Series, Three Phase 20 - 120 kVA

The Ultron HPH is a true online double-conversion UPS offering the best-in-class combination of maximum available power, unbeatable energy efficiency and superior power performance for small data centers and other mission critical applications requiring highly reliable power protection. With fully rated power (kVA=kW); the Ultron HPH provides maximum available power without de-rating the UPS. Thanks to three level inverter and Delta's innovative three phase PFC topology, it features low iTHD <3%, up to 96 % AC-AC efficiency and 99% efficiency in ECO mode resulting in significant TCO (Total Cost of Ownership) savings. Facilitating increased availability through special watch-dog design, the Ultron HPH is an ideal solution for protecting your mission critical operations.

Applicable Sectors



Data Center



Telecom



Industrial



Network



Security



Lab



Medical



Metro



Banking

Features:

- Fully rated power (kVA=kW) for maximum power availability
- Leading AC-AC efficiency up to 96% saves energy costs
- Low harmonic pollution (iTHD<3%) and high input power factor (>0.99) reduce upstream investment costs
- Wide input voltage range allows the UPS to operate in harsh electrical environments and extends battery life
- DSP based technology enables reduction in the number of electronic components to lower failure rate
- Redundant auxiliary power and fan design* enhance system reliability
- A wide choice of configurations, such as N+X redundancy and hot stand-by
- Adjustable charging current and charging voltage meet different battery configuration requirements
- Flexible battery configuration optimizes battery investment
- Front-door battery replacement with hot-swappable battery tray design supports easy and quick replacement without turning the unit off (HPH-B / BN)
- Swappable interior architecture enables quick and easy maintenance*
- Multi-connectivity interface supports remote UPS monitoring and management

* Applied for 60-120kVA models

Technical Specification

Model		HPH-20K HPH-20K-BN/B	HPH-30K HPH-30K-BN/B	HPH-40K HPH-40K-BN/B	HPH-60K	HPH-80K	HPH-100K	HPH-120K
Power Rating		20kVA/kW	30kVA/kW	40kVA/kW	60kVA/kW	80kVA/kW	100kVA/kW	120kVA/kW
Input	Nominal Voltage	380/220 Vac; 400/230 Vac; 415/240 Vac (3 phase, 4-wire + G)						
	Voltage Range	300~477 Vac (full load); 228~300 Vac (70%~100% load)			332~477 Vac (full load); 228~332 Vac (63%~100% load)			
	Frequency	40 ~ 70 Hz						
	Power Factor	> 0.99 (full load)						
	Current Harmonic Distortion	< 3%						
Output	Voltage	380/220 Vac; 400/230 Vac; 415/240 Vac (3 phase, 4-wire + G)						
	Voltage Regulation	± 1 %						
	Voltage Harmonic Distortion	< 1.5% (linear load)			< 2% (linear load)			
	Overload Capability	≤ 105%: continuous; 106% ~ ≤125%: 10 minutes; 126% ~ ≤150%: 1 minute; >150%: 1 second						
	Output Power Factor	1						
	Frequency	50/60 Hz ± 0.05 Hz						
Battery	Battery Voltage	240 Vdc						
	Type	Support SMF/VRLA/Tubular/Ni-Cd						
	Quantity	32-50 pcs			32-46 pcs***			
	Charge Current (Max.)	5A	9A	9A	10A	15A	20A	20A
	Built-in							
	Additional charger board (optional)				20A	20A	40A	40A
	Typical Backup Time **	15 min	10 min	9.5 min				
Communication Interfaces		SMART Slot x 1, MINI Slot x 1, Parallel Port x 2, RS232 Port x 1, REPO Port x 1, Charger Detection Port x 1, Input Dry Contact x 2, Output Dry Contact x 6, USB Port x 1*						
Conformance	Safety	CE, RCM						
Other Features	Parallel Redundancy	Up to 4 units						
	Emergency Power Off	Local and remote						
	Maintenance Bypass Switch	Yes						
Efficiency	AC-AC	Up to 96%			> 96% (HPH 40-120K peak efficiency is tested by TÜV)			
	ECO Mode	Up to 99%						
Environment	Operating Temperature	0 ~ 40 °C						
	Relative Humidity	5 ~ 95 % (non-condensing)						
	Audible Noise	< 55 dB	< 60 dB	< 65 dB				
	IP Protection	IP20						
Physical	Dimensions (W x D x H)	380 x 800 x 800 mm			520 x 800 x 1175 mm	520 x 800 x 1760 mm		
	Weight	66.5 kg	86.06 kg	86.5 kg	186.5 kg	191 kg	312 kg	312 kg
Physical (BN / B)	Dimensions (W x D x H)	490 x 830 x 1400 mm						
	Weight (with batt.)	351 kg	371 kg	371 kg				
	Weight (without batt.)	128 kg	148 kg	148 kg				

HPH-B: UPS integrated battery model has batteries inside

HPH-BN: UPS integrated battery model has no batteries inside

* Applied for models HPH-60/80/100/120K

** At 70% load with internal battery strings

*** UPS needs de-rating for battery quantity 32-36 pcs. Please contact authorized Delta personnel

All specifications are subject to change without prior notice.



2007~ 2008 Forbes Asia's Fabulous 50



2009 Frost & Sullivan Green Excellence Award for Corporate Leadership



Delta's Manufacturing System is Certified by ISO 9001 and ISO 14001 Standards



IECQ Certificate of Hazardous Substance Process Management



TÜVRheinland®
Precisely Right.

Delta Ultron HPH 40~120kVA Efficiency is tested by TÜV



Delta UPS – Ultron Family



HPH Series, Three Phase 20 - 60 kVA, 208/120V

The Ultron HPH is a true online double-conversion UPS offering the best-in-class combination of maximum available power, unbeatable energy efficiency and superior power performance for small data centers and other mission critical applications. With fully rated power (kVA=kW), the Ultron HPH provides maximum available power without de-rating the UPS. Thanks to the three level IGBT topology for both PFC (power factor correction) and inverter, the Ultron HPH features up to 94% AC-AC efficiency. Delta's advanced digital PFC control also contributes low iTHD < 3% and high input power factor > 0.9 resulting in significant TCO (Total Cost of Ownership) savings. Facilitating increased availability and power performance, the Ultron HPH is an ideal solution for protecting your mission critical operations.

Features:

- Fully rated power (kVA=kW) for maximum power availability
- Leading AC-AC efficiency up to 94% saves energy costs
- Low harmonic pollution (iTHD<3%) and high input power factor (>0.99) reduce upstream investment costs
- Parallel expansion and N+X redundancy up to 4 units
- Redundant auxiliary power and fan design enhance system reliability
- Optional IPX1 level protection
- A wide choice of configurations, such as N+X redundancy and hot stand-by
- Adjustable charging current and charging voltage meet different battery configuration requirements
- Flexible battery configuration optimizes battery investment
- Front-door battery replacement with hot-swappable battery tray design supports easy and quick replacement without turning the unit off
- Swappable interior architecture and front access servicing enables quick and easy maintenance
- Multi-connectivity interface supports remote UPS monitoring and management

Applicable Sectors



Datacenter



Telecom



Industrial



Banking



Lab



Medical



Network



Security



Metro

Technical Specification

Model		HPH-20K-LV-B	HPH-30K-LV-B	HPH-40K-LV-B	HPH-60K-LV-B
		HPH-20K-LV-BN	HPH-30K-LV-BN	HPH-40K-LV-BN	HPH-60K-LV-BN
Power Rating	20kVA/20kW	20kVA/20kW	30kVA/30kW	40kVA/40kW	60kVA/60kW
Input	Nominal Voltage	208/120Vac, 220/127Vac (3 phase, 4-wire + G)			
	Voltage Range	125~253Vac(L-L) / 72~146Vac(L-N)*			
	Frequency Range	40~70 Hz			
	Power Factor	> 0.99 (full load)			
	Current Harmonic Distortion	< 3%			
Output	Voltage	208/120Vac, 220/127Vac (3 phase, 4-wire + G)			
	Voltage Regulation	± 1%			
	Voltage Harmonic Distortion	< 3% (linear load)			
	Overload Capability	<105% continuous; 105%~125%: 10minute; 125~150%: 1minute; >150%: 0.5 second			
	Output Power Factor	1			
	Frequency	50/60 Hz ± 0.05 Hz			
Battery	Battery Quantity	Adjustable ± 11~13pcs (default 12 pcs)			
	Type	Support SMF and VRLA			
	Charge Current (Max.)	10A			
	Charge Voltage	Float charge 163 ± 3 Vdc ; Boost charge 168 ± 3 Vdc (default 12 pcs)			
	Backup Time**	9.5 min (9Ah*48pcs)	9.5 min (9Ah*72pcs)	6.5 min (9Ah*72pcs)	5.2 min (9Ah*96pcs)
Communication Interfaces		SMART Slot x 1, MINI Slot x 1, Parallel Port x 2, RS232 Port x 1, REPO Port x 1, Charger Detection Port x 1, Input Dry Contact x 2, Output Dry Contact x 6			
Display		LED indicators and Multi-language LCD display			
Conformance	Safety	UL, cUL, Energy Star			
Other Features	Parallel Redundancy	Up to 4 units			
	Emergency Power Off	Local and remote			
Efficiency	AC-AC Mode	Up to 94%			
	ECO Mode	Up to 98%			
Environment	Operating Temperature	0 ~ 40°C			
	Ambient Storage Temperature	-20 ~ 40°C			
	Relative Humidity	0 ~ 95% (non-condensing)			
	Audible Noise	< 65 dB		< 70 dB	
Physical	Dimensions (W x D x H)	520 x 800 x 1380 mm		520 x 800 x 1760 mm	
	Weight (with battery)	340 kg	420 kg	450 kg	530 kg
	Weight (without battery)	196 kg	204 kg	224 kg	242 kg

HPH-20K-LV-B: UPS integrated battery model has batteries inside

HPH-20K-LV-BN: UPS integrated battery model has no batteries inside

* When input voltage range is 72~108Vac(L-N) and 125~187Vac(L-L), the sustainable loading is from 63% to 100% of UPS capacity.

** At 70% load with internal battery strings.

All specifications are subject to change without prior notice.



2007~ 2008 Forbes Asia's Fabulous 50



2009 Frost & Sullivan Green Excellence Award for Corporate Leadership



Delta's Manufacturing System Certified by ISO 9001 and ISO 14001



IECQ Certificate of Hazardous Substance Process Management



Delta UPS – Ultron Family



HPH Series, Three Phase

160 - 200 kVA

The brand-new Ultron HPH series 160-200kVA is a true online double-conversion UPS offering the best-in-class combination of power performance and efficiency for medium data centers, pan-IT, and other mission critical applications. Thanks to Delta's R&D expertise and excellent engineering capabilities, the Ultron HPH features up to 96.5% AC-AC efficiency, low iTHD < 3%, and high input power factor > 0.99 resulting in significant total cost of ownership (TCO) savings. Highlights of the highly reliable Ultron HPH series UPS design include key component redundancy and proactive battery health detection. With its combination of superior availability and power performance, the Ultron HPH 160-200kVA is the top choice for power protection of sustainable medium business operations.

Features:

- High AC-AC efficiency of up to 96.5% and ECO mode to 99% for significant energy cost savings
- Low harmonic pollution (iTHD < 3%) and high input power factor (> 0.99) reduces upstream investment costs
- Optional redundant controller supports dual CAN bus and ring connection for high system availability
- Proactive battery aging detection for high reliability
- Easy event log check via touch panel and firmware upgrade via USB port
- Parallel expansion and redundancy up to 8 units, 1.6MVA of total power capacity
- Flexible battery configuration 30~46 pieces optimizes battery investment
- Supports either top or bottom cable entry in the single cabinet. The unique fixed symmetric terminal design avoids cable bending issues to enhance cable reliability
- User-friendly 10" colored LCD with touch panel enables easy local UPS management
- Environment information such as security, water, fire and temperature can be integrated into the UPS for easy monitoring via the LCD of the UPS
- If the UPS is equipped with Delta's battery management system, the battery information can be integrated into the UPS and monitored via LCD

Applicable Sectors



Datacenter



Telecom



Industrial



Banking



Lab



Medical



Network



Security



Metro

Technical Specification

Model		HPH-160K	HPH-200K
Power Rating		160kVA* / 150kW	200kVA / 200kW
Input	Nominal Voltage	220/380 Vac, 230/400 Vac, 240/415 Vac (3-phase, 4-wire + G)	
	Voltage Range	176 ~ 276Vac (full load)	
	Current Harmonic Distortion	≤3% **	
	Frequency	40 ~ 70 Hz	
Output	Voltage	220/380 Vac, 230/400 Vac, 240/415 Vac (3-phase, 4-wire + G)	
	Voltage Harmonic Distortion	≤0.5% (linear load)	
	Frequency	50/60 Hz	
	Frequency Regulation	±0.05 Hz (battery mode)	
	Overload Capability	≤125%: 10 minutes ; ≤150%: 1 minute	
Display		10" color touch screen	
Interface	Standard	RS232 x 1, Parallel port x 2, USB x 3, RS485 x 1, Relay I/O card slot x 1, REPO x 1, Input dry contact x 4, Output dry contact x 6, Battery temperature sensor x 4, External switch detection x 4, RJ45 x 1, Ethernet x 1	
	Optional	Relay I/O card, Battery cabinet temperature sensor cable	
Confirmation	Safety	CE, RCM	
Efficiency	AC-AC Mode	Up to 96.5%	
	ECO Mode	99%	
Battery	Nominal Voltage	±240 Vdc	
	Charge Voltage	±272 Vdc (adjustable from 204V to 312V)	
	Battery number configuration	30 ~ 46pcs (default: 40pcs)	
Environment	Operating Altitude	1000 meters (without derating)	
	Operating Temperature	0 ~ 40°C	
	Audible Noise	<70 dB	
	Relative Humidity	0 ~ 95% (non-condensing)	
Others	Parallel Redundancy and Expansion	Maximum 8 units	
	Remote Emergency Power Off	Yes	
	Battery Start	Yes	
Physical	Dimensions (W x D x H)	600 x 1100 x 1600 mm	
	Weight	339 kg	376 kg

* The power rating is adjustable from default 160kVA to 150kVA via touch panel

** When input vTHD is less than 1%

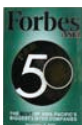

2007~ 2008 Forbes Asia's Fabulous 50



2009 Frost & Sullivan Green Excellence Award for Corporate Leadership



Delta's Manufacturing System is Certified by ISO 9001 and ISO 14001



IECQ Certificate of Hazardous Substance Process Management



Delta UPS – Ultron Family



NT Series, Three Phase 20 - 500 kVA

The Ultron NT series is a three phase UPS featuring customized I/P-O/P ratings for various applications. With N+X parallel redundancy or expansion, it guarantees high availability and reliability for your critical loads.

The Ultron NT series offers continued seamless protection for your business even under 100% unbalanced loading conditions. Its economy mode improves efficiency and saves operating cost.

Features:

- Available from 20 to 4,000 kVA (8 x 500 kVA in parallel)
- Parallel redundancy without requiring extra hardware to increase reliability
- Built-in isolation transformer protects user equipment
- Optional harmonic filter and 12-pulse rectifier
- Redundant auxiliary power and control circuit ensures higher reliability
- Inbuilt maintenance and static bypass switch
- Multi-language LCD display and LED status indicators
- RS232, RS485 and six programmable dry contact outputs
- Compatible with generator installation and unbalanced loads
- Parallel expansion as your business grows and consequently saves initial investment
- Wide input voltage range extends battery lifetime
- Economy mode saves energy and operating cost
- Common battery installation saves initial investment

Applicable Sectors



Data Center



Telecom



Industrial



Network



Security



Lab



Medical



Metro

Technical Specification

Model		NT-20K	30K	40K	50K	60K	80K	100K	120K	160K	200K	260K	320K	400K	500K					
Power Rating - kVA		20	30	40	50	60	80	100	120	160	200	260	320	400	500					
Power Rating - kW		16	24	32	40	48	64	80	96	128	160	208	256	320	400					
Input	Nominal Voltage	208/120; 380/220; 400/230; 415/240; 480/277 Vac (3 phase, 4-wire + G)																		
	Voltage Range	305 ~ 499 Vac																		
	Current Harmonic Distortion	< 3% (with optional power filter, full load)																		
	Frequency	45 ~ 65 Hz																		
Output	Voltage	208/120; 380/220; 400/230; 415/240; 480/277 Vac (3 phase, 4-wire + G) 220/230/240 Vac (1 phase) *																		
	Output Power Factor	0.8																		
	Voltage Harmonic Distortion	≤ 3% (linear load)																		
	Voltage Regulation	± 1% (static)																		
	Frequency	50/60 Hz ± 0.01% (internal oscillator); ± 1% (synchronized)																		
	Overload Capability	≤ 110%: 60 minutes; 110~125%: 10 minutes; 126~150%: 1 minute																		
Communication Interfaces	Standard	RS232 x 1, RS485 x 2, SMART slot x 1, Output dry contact x 6																		
Other Features	Parallel Redundancy	Up to 8 units																		
	Emergency Power Off	Local and remote																		
	Event Log	500 records																		
	Input Harmonic Improvement	Optional harmonic filter and 12-pulse rectifier																		
Efficiency	AC-AC	90%	91%	91.5%	92%	92.5%	93%													
	ECO Mode	> 97%	> 97.5%																	
Environment	Operating Temperature	0 ~ 40°C																		
	Relative Humidity	0 ~ 95% (non-condensing)																		
	IP Protection	IP20																		
	Audible Noise (at 1.5 meters)	≤ 60 dB				≤ 65 dB				≤ 68 dB			≤ 72 dB			≤ 77 dB				
Physical-6pulse	Dimensions	Width	mm	600				800			1200			1600			n/a			
		Depth	mm	800				830			830			995			n/a			
		Height	mm	1400				1700			1700			1950			n/a			
	Weight	kg	365	365	425	460	506	525	700	745	1050	1085	1680	1720	1920					
Physical-12pulse	Dimensions	Width	mm	600				830			1200			1400			1600			1900
		Depth	mm	800				800			830			800			995			995
		Height	mm	1400				1700			1700			1700			1950			1950
	Weight	kg	450	500	590	640	690	860	1070	1120	1430	1560	2150	2400	2645	3110**				

* Single phase output voltage: 220/230/240 is only for 20 ~ 40 kVA models.

** 500 kVA model is assembled into two cabinets: Inverter (width=1100 mm, 1760 kg) and Rectifier (width=800 mm, 1350 kg).

All specifications are subject to change without prior notice.



2007 ~ 2008 Forbes Asia's Fabulous 50



2009 Frost & Sullivan Green Excellence Award for Corporate Leadership



Delta's Manufacturing System is Certified by ISO 9001 and ISO 14001 Standards



IECQ Certificate of Hazardous Substance Process Management



Delta UPS – Ultron Family

DPS Series, Three Phase 160 - 500 kVA



Applicable Sectors



Data Center



Telecom



Industrial



Network



Security



Lab



Medical



Metro

Delta's Ultron DPS is a double-conversion and IGBT-rectifier three phase UPS. With the three level IGBT topology for both PFC (power factor correction) and inverter, the Ultron DPS features industry leading performance of up to 96% AC-AC efficiency.

Thanks to Delta's advanced digital PFC control, it also has low iTHD < 3% and high input power factor > 0.99 resulting in significant total cost of ownership (TCO) savings.

Aiming to achieve the highest availability possible, Delta has enhanced special designs for battery management, swappable fans and ease of maintenance.

The excellent power performance and high system availability of the Ultron DPS provide customers with the benefits of a stable power supply, high power efficiency, low capital investment and low overall operation cost.

Features:

- N+X redundancy or hot-standby configuration increases system reliability
- Wide input voltage range allows the UPS to work in harsh electrical environments
- Field programmable sequential start-up
- Intelligent fan speed control and redundant fan design prevent overheating
- Comprehensive battery management sustains battery lifetime and optimal operation
- High efficiency even at light load saves operating costs
- High input power factor (> 0.99) and low input harmonic distortion (iTHD < 3%) save upstream investment
- Parallel expansion without extra hardware allows quick capacity upgrade to meet business growth
- Swappable fans reduce maintenance lead time
- Built-in manual bypass allows "zero downtime" to ensure system availability during service maintenance
- Main input, output and bypass switches detection provide quick diagnosis when faults occur

Technical Specification

Model		DPS-160K	DPS-200K	DPS-300K	DPS-400K	DPS-500K
Power Rating		160kVA/144kW	200kVA/180kW	300kVA/270kW	400kVA/360kW	500kVA/450kW
Input	Nominal Voltage	380/220 Vac; 400/230 Vac; 415/240 Vac (3 phase, 4-wire +G)				
	Voltage Range	324 ~ 477 Vac (full load); 242 ~ 324 Vac (70% ~ 100% load)				
	Current Harmonic Distortion	< 3%*				
	Power Factor	> 0.99				
	Frequency	45 ~ 65 Hz				
Output	Voltage	380/220 Vac; 400/230 Vac; 415/240 Vac (3 phase, 4-wire +G)				
	Output Power Factor	0.9				
	Voltage Harmonic Distortion	≤ 1.5 % (linear load)				
	Voltage Regulation	± 1% (static)				
	Frequency	50/60 Hz ± 0.05 Hz				
	Overload Capacity	≤ 125%: 10 minutes; ≤ 150%: 1 minute				
Communication Interfaces	Standard	RS232 x 1, Smart slot x 2, Output dry contact x 6, Input dry contact x 2, REPO x 1, External battery cabinet status detection x 1, External battery cabinet temperature detection x 4, Parallel port x 2, USB port x 1				
Display		Mimic LCD supports multi-language and LED indicators				
Conformance	Safety	CE, RCM				
Other Features	Parallel Redundancy	Up to 8 units				
	Emergency Power Off	Local and remote				
	Event Log	500 records				
Efficiency	AC-AC	Up to 96%				
	ECO Mode	Up to 99%				
Environment	Operating Temperature	0 ~ 40°C				
	Relative Humidity	0 ~ 95% (non-condensing)				
	Audible Noise (at one meter)	< 70 dB		< 73 dB		< 76 dB
	IP Protection	IP20				
Physical	Dimensions (W x D x H)	850 x 865 x 1950 mm		1600 x 865 x 1950 mm		
	Weight	697 kg		1200 kg		1220 kg

* When input harmonic distortion is less than 1%.
All specifications are subject to change without prior notice.



2007~ 2008 Forbes Asia's Fabulous 50



2009 Frost & Sullivan Green Excellence Award for Corporate Leadership



Delta's Manufacturing System is Certified by ISO 9001 and ISO 14001 Standards



IECQ Certificate of Hazardous Substance Process Management



TÜVRheinland®
Precisely Right.

Delta Ultrion DPS 160~400kVA Efficiency is Tested by TÜV



Delta UPS – Ultron Family



Applicable Sectors



Data Center



Telecom



Industrial



Network



Banking



Infrastructure



Medical



Metro



Government



Education

DPS Series, Three Phase 500 - 1200 kVA

Delta's superior Ultron DPS series 500 - 1200kVA UPS supports unity output power factor to deliver up to 10 MW power capacity to meet the demands for large data centers and colocations. The Ultron DPS series guarantees the highest level of system reliability by supporting self-detection of key components with pre-warning function, multi-layered redundancy design, and complete power rating coverage. Along with optional battery management software, the DPS series enables users to achieve predictive maintenance and minimize system downtime, while lowering the total cost of ownership (TCO).

Features:

- Supports up to 10 MW power capacity with the parallel redundancy and expansion up to 8 units
- Redundancy components and dual CAN bus ensures system availability
- Proactive detection of key component status for early diagnosis on UPS malfunction
- Intelligent battery health diagnosis enables better battery maintenance and replacement
- Advanced event analysis, including 10,000 event logs, waveform capturing and key parameters recording, to detect UPS abnormality and ensure higher availability
- The industry's leading power density and smallest footprint with the design of both top/button cable entry and inbuilt switches
- Unity output power factor guarantees no-rating and provides 100% kW
- AC-AC efficiency of up to 96.5% and 99% in ECO mode resulting in marked energy cost savings
- Supports both VRLA and environment-friendly Li-ion batteries
- Environment information, such as security, water, fire, and temperature can be integrated and monitored via the LCD panel of the UPS
- If the UPS is equipped with an external battery management system, the battery information can be integrated and monitored via the LCD panel of the UPS
- Flexible battery quantity of 30-46 pcs achieves optimal battery investment

Technical Specification

Model		DPS-500K	DPS-600K	DPS-1000K	DPS-1200K
Power Rating	kVA	500	600	1000	1200
	kW	500	600	1000	1200
Input	Nominal Voltage	220/380V, 230/400V, 240/415V (3-phase, 4-wire + G)			
	Voltage Range	176/304~276/478 VAC (full load)			
	Current Harmonic Distortion	<3% (with Full Linear Load); <5% (with Full Non-linear Load)			
	Power Factor	> 0.99			
	Frequency Range	40 ~ 70 Hz			
Output	Voltage	220/380V, 230/400V, 240/415V (3-phase, 4-wire + G)			
	Voltage Harmonic Distortion	<1.5% (Linear Load); <5% (Non-linear Load)			
	Voltage Regulation	±1 (static); ±5 (dynamic)			
	Output Power Factor	1			
	Frequency	50/60Hz (Auto-Selectable)			
	Overload Capability	≤ 125%: 10 min ; ≤ 150%: 1 min ; >150%: 1 sec			
Display		10" Color Touch Panel			
Interface	Standard	RS232, Parallel port, USB, Modbus RS485, Input dry contact, Output dry contact, SNMP card inbuilt in touch screen			
	Optional	Relay I/O card, Battery cabinet temperature sensor cable			
Conformance	Safety	CE			
Efficiency	AC-AC Mode	Up to 96.5%			
	ECO Mode	99%			
Battery	Type	VRLA, LiB			
	Charge Current	150A	180A	300A	360A
	Battery Quantity	30 – 46 pcs			
Environment	Operating Temperature	0 ~ 40°C			
	Relative Humidity	0 ~ 95% (non-condensing)			
	Audible Noise	<80 dB			
	IP Protection	IP 20			
Others	Parallel Redundancy and Expansion	Maximum 8 units			
	Emergency Power Off	Remote and local			
Physical	Dimensions (W x D x H)	1200 x 900 x 2000 mm		2800 x 900 x 2000 mm	
	Weight	890kg	950kg	1870kg	2000kg

All specifications are subject to change without prior notice.



2007–2008 Forbes Asia's Fabulous 50



2009 Frost & Sullivan Green Excellence Award for Corporate Leadership



Delta's Manufacturing System is Certified by ISO 9001 and ISO 14001 Standards



IECQ Certificate of Hazardous Substance Process Management



Delta UPS – Ultron Family

DPM Series, Three Phase 500 - 1375 kVA, 480V



Applicable Sectors



Data Center



Telecom



Industrial



Network



Security



Lab



Medical



Metro

The Ultron DPM is a true online double-conversion UPS offering the maximum available power, energy efficiency, and power performance for large data centers requiring high power ratings and highly reliable power protection. Capable of parallel expansion up to 8 units, this product series is expected to fulfill the requirements for the Megawatt power demands of large data centers. With fully rated power (kVA=kW), the DPM series provides maximum available power without de-rating the UPS. Owing to Delta's Three Phase PFC topology, it also features low iTHD <3%, up to 96% AC-AC efficiency and 99% efficiency in ECO mode resulting in significant TCO (Total Cost of Ownership) savings. The self-diagnosis of key components providing proactive maintenance and aging detection effectively minimizes downtime risks. The Ultron DPM series UPS is the most suitable power protection for safeguarding the continuity of large data center businesses.

Features:

- AC-AC efficiency up to 96%, efficiency optimization at light loads and efficient ECO mode up to 99% saves energy costs
- Robust ECO mode up to 98.5% efficiency with higher system reliability
- Low harmonic pollution (iTHD<3%) & high input power factor (>0.99)
- Smart modular design with internal redundancy achieves fault isolation for higher reliability
- Self-diagnosis and aging detection via data collection and analysis provide predictive maintenance to minimize downtime risk
- Key component redundancy allows individual faults for higher UPS availability
- Supports both top and bottom cable entry for flexible configurations, and fully front access.
- Up to eight UPS units can be paralleled for redundancy or expansion
- Adjustable battery charging voltage adapts to multiple types of batteries.
- Intuitive HMI touchscreen enables easier UPS information access and operation
- Built-in USB port is standard for easy access to over 5000 data logs for event diagnosis
- SNMP card is equipped as standard for remote monitoring and management

Technical Specification

Model		DPM-500K	DPM-550K	DPM-600K	DPM-750K	DPM-800K	DPM-1000K	DPM-1100K	DPM-1200K	DPM-1375K
Power Rating	kVA	500	550	600	750	800	1000	1100	1200	1375
	kW	500	500	600	750	800	1000	1000	1200	1200
Input	Nominal Voltage	480 Vac, 3P3W								
	Voltage Range	+10/-15%, 408-528 Vac (full load)								
	Frequency	50/60Hz +/- 5Hz								
	Power Factor	> 0.99 (full load)								
	Current Harmonic Distortion	< 3%								
Output	Voltage	480 Vac, 3P3W								
	Output Power Factor	up to 1								
	Voltage Regulation	±1 %								
	Voltage Harmonic Distortion	< 1.5 % (linear load)								
	Overload Capability	101% ~ ≤125%: 10 minutes; 126% ~ ≤150%: 1 minute; >150%: 1 second								
	Frequency	50/60Hz +/- 0.05Hz								
External Battery	Compatible Type	VRLA, vented								
	Battery Voltage	480 Vdc								
	Quantity	38 ~ 42 pcs								
	Charge Current	140A		210A		280A		350A		
Display	LCD	Touch Screen								
Communication Interfaces		Smart Slot x 1, Parallel Port x 2, REPO Port x 1, Input Dry Contact x 2, Output Dry Contact x 6, Breaker Detection x 4, USB Port x 2, RS-232 x 1, SNMP Card x 1, Battery Temperature Detection x 4								
Parallel Operation	Redundancy and Expansion	Up to 8 units								
Efficiency	Online Mode	Up to 96% (95% at 30% load)								
	ECO Mode	Up to 99%								
Environment	Operating Temperature	0 ~ 40 °C								
	Relative Humidity	0 ~ 95% (non condensing)								
	Audible Noise	< 75 dB								
	Protection Level	IP20								
Physical	Dimensions (W x D x H)	2130 x 875 x 1900 mm	2745 x 875 x 1900 mm			3910 x 875 x 1900 mm	4525 x 875 x 1900 mm			
		84.3 x 34.4 x 74.8 in	108.7 x 34.4 x 74.8 in			146.5 x 34.4 x 74.8 in	182.1 x 34.4 x 74.8 in			
	Weight	1300 kg	2000 kg			2700 kg	3400 kg			
		2866 lbs	4409 lbs			5952 lbs	7496 lbs			

All specifications are subject to change without prior notice.



2007-2008 Forbes Asia's Fabulous 50



2009 Frost & Sullivan Green Excellence Award for Corporate Leadership



Delta's Manufacturing System Certified by ISO 9001 and ISO 14001



IECQ Certificate of Hazardous Substance Process Management



Delta UPS – Modulon Family

NH Plus Series, Three Phase 20 - 120 kVA



Applicable Sectors



Data Center



Telecom



Industrial



Network



Security



Lab



Metro

The Modulon NH Plus series is Delta's modular UPS featuring high efficiency, hot-swappable modular structure and N+X redundancy. With its high efficiency, the NH Plus series delivers remarkably low total cost of ownership in terms of both capital expense and operating expense.

With N+X module and system redundancy to guarantee reliability and availability, the Modulon NH Plus series is an excellent UPS solution to protect the mission critical applications.

Features:

- Available from 20 to 480 kVA (4 units x 120 kVA in parallel)
- Redundancy at module and system level
- Hot-swappable function ensures uninterrupted operations during maintenance
- Redundant auxiliary power and control circuit ensures higher reliability
- Inbuilt maintenance and static bypass switch
- Modular design provides easy maintenance and scalability
- Multi-language LCD display and LED status indicators
- Two SMART slots and six programmable dry contact outputs
- Optional external battery cabinet for longer backup time
- Low harmonic distortion (iTHD<3%) optimized generator size to save initial investment
- High input and output power factor (I/P PF >0.99; O/P PF up to 0.9) and 94% high efficiency reduce operating costs

Technical Specification

Model		NHP-20K	NHP-40K	NHP-60K	NHP-80K	NHP-100K	NHP-120K
Power Rating*		20kVA/18kW	40kVA/36kW	60kVA/54kW	80kVA/72kW	100kVA/90kW	120kVA/108kW
Input	Nominal Voltage	380/220; 400/230; 415/240 Vac (3 phase, 4-wire + G)					
	Voltage Range	300 ~ 477 Vac (full load); 208 ~ 300 Vac (70% ~ 100% load)					
	Current Harmonic Distortion	< 3% (full load)					
	Power Factor	> 0.99					
	Frequency	45 ~ 65 Hz					
Output	Voltage	380/220; 400/230; 415/240 Vac (3 phase, 4-wire + G)					
	Output Power Factor	0.9					
	Voltage Harmonic Distortion	< 3% (linear load)					
	Voltage Regulation	± 1% (static)					
	Frequency	50/60 Hz ± 0.05 Hz					
	Overload Capability	≤ 125%: 10 minutes; ≤ 150%: 1 minute					
Interface	Standard	RS232 x 1, SMART slot x 2, Output dry contact x 6, Input dry contact x 2, Battery cabinet temperature x 4, Battery cabinet status detection x 1, Parallel port x 1, REPO x 1					
Conformance	Safety	CE, RCM					
Other Features	Parallel Redundancy	Module and system redundancy; Maximum 4 units in parallel up to 480 kVA					
	Emergency Power Off	Local and remote					
	Event Log	500 records					
Efficiency	AC-AC	94%					
	ECO Mode	97%					
Environment	Operating Temperature	0 ~ 40°C					
	Relative Humidity	0 ~ 95% (non-condensing)					
	Audible Noise (at one meter)	< 65 dB	< 68 dB	< 68 dB	< 70 dB	< 72 dB	< 73 dB
	IP Protection	IP20					
Physical	Dimensions	UPS	520 x 855 x 1165 mm			520 x 975 x 1695 mm	
	(W x D x H)	Battery Pack	520 x 855 x 1165 mm (26 Ah x 40 pcs)			520 x 855 x 1695 mm (40 Ah x 40 pcs)	
	Weight		170 kg	200 kg	230 kg	260 kg	350 kg

* Power rating in kW is subject to reconfiguration of the UPS; Delta provides the configuration service. All specifications are subject to change without prior notice.



2007~2008 Forbes Asia's Fabulous 50



2009 Frost & Sullivan Green Excellence Award for Corporate Leadership



Delta's Manufacturing System is Certified by ISO 9001 and ISO 14001 Standards



IECQ Certificate of Hazardous Substance Process Management



Delta UPS – Modulon Family

DPH Series, Three Phase 25 - 75/150/200 kVA



Applicable Sectors



Data Center



Telecom



Industrial



Network



Security



Lab



Metro



Banking

The Modulon DPH supports ultimate availability for data center operations and provides the benefit of “pay as you go” without over-sizing the UPS. While achieving ultimate availability, the Modulon DPH does not compromise on power efficiency performance. When availability, efficiency and expanding according to business needs are essential, the Modulon DPH is the ideal UPS system to provide power protection and total cost of ownership (TCO) savings.

Features:

- Advanced fault tolerance design achieved by self redundancy to guarantee operation continuity
- Self-synchronization of power and control modules for continuous on-line operation even in the event of control module failure to avoid downtime caused by single point failure
- Hot-swappable key modules and components to ensure Mean Time To Repair (MTTR) close to zero without downtime risk
- Vertical expansion from 25kW to 75/150/200kW supporting N+X redundancy in a single rack enclosure to save footprint
- Parallel expansion up to four units without requiring additional hardware
- Optional Rack-Mount Remote Power Panel (rRPP) (applicable for 75/150kW models) has flexibility to arrange its UPS's output power feeding according to its connected critical loads
- Optional built-in battery modules (applicable for 75kW models) at maximum four units (four battery trays each)
- Full rated power (kVA=kW) to maximize power availability
- High operating efficiency of 95% at 30% load and 96% from 50% load resulting in marked energy cost savings
- Low harmonic pollution (iTHD<3%) to reduce upstream investment costs and meet demanding power requirements
- Built-in manual bypass features to eliminate maintenance-related downtime
- Proactive detection of fan failure and switch fault for early diagnosis on UPS malfunction
- Plug and play modularity to simplify the maintenance process

Technical Specification

Model		DPH-75K	DPH-150K	DPH-200K	
Power Rating		75kVA	150kVA	200kVA	
Power Module Rating		25kW			
Input	Nominal Voltage	380/220 Vac; 400/230 Vac; 415/240 Vac (3 phase, 4-wire +G)			
	Voltage Range	305 ~ 477 Vac (full load); 242 ~ 305 Vac (55% ~ 100% load)			
	Current Harmonic Distortion	< 3% *			
	Power Factor	> 0.99			
	Frequency	45 ~ 65 Hz			
Output	Voltage	380/220 Vac; 400/230 Vac; 415/240 Vac (3 phase, 4-wire +G)			
	Output Power Factor	1			
	Voltage Harmonic Distortion	≤ 2% (linear load)			
	Voltage Regulation	± 1% (static)			
	Frequency	50/60 Hz ± 0.05 Hz			
	Overload Capacity	≤ 125%: 10 minutes; ≤ 150%: 1 minute			
Interface	Standard	System communication port x 1, LCM port x 1, Parallel port x 2, Smart slot x 2, Output dry contact x 6, Input dry contact x 2, Battery dry contact x 2, REPO			
Conformance	Safety	BSMI, CE, RCM			
Other Features	Parallel Redundancy and Expansion	Module and system redundancy; Maximum 4 units			
	Emergency Power Off	Local and remote			
	Battery start	Yes			
	Event Log	3000 records			
Efficiency	AC-AC	Up to 96% (Tested by TÜV)			
	ECO Mode	99%			
Environment	Operating Temperature	0 ~ 40 °C			
	Relative Humidity	0 ~ 95% (non-condensing)			
	Audible Noise (at one meter)	< 62 dB			
	IP Protection	IP20			
Physical	Dimensions (W x D x H)	600 x 1090 x 2000 mm			
	Weight	UPS System	310 kg	320 kg	350 kg
		Power Module	32 kg	32 kg	32 kg
		Rack-mount RPP	32 kg	32 kg	N/A
		Battery Module	29.5 kg	N/A	N/A
System Frame	25kW Power Module	3	6	8	
Maximum Capacity	Rack-mount RPP	1	2	N/A	
	Breaker Module (for Rack-mount RPP)	6	12	N/A	
	Battery Module	4	N/A	N/A	

* When input vTHD is less than 1%.

All specifications are subject to change without prior notice.



2007-2008 Forbes Asia's Fabulous 50



2009 Frost & Sullivan Green Excellence Award for Corporate Leadership



Delta's Manufacturing System is Certified by ISO 9001 and ISO 14001 Standards



IECQ Certificate of Hazardous Substance Process Management



Delta UPS – Modulon Family



DPH Series, Three Phase

50 - 600 kVA

In this IT intensive world with heavy data traffic driven by cloud, 4G/5G and media streaming applications, IT managers are facing the challenges of increasing rack power density and limited data center space. Delta's innovative modular UPS technologies provide the answer to customers' demand for high power density, high power performance, and ultimate availability. The brand-new Delta Modulon DPH series UPS 50-600kVA achieves the industry's leading power density of 55.6kVA per module, offering the smallest footprint and best space utilization. The Modulon DPH 50-600kVA UPS is the ideal modular power protection for MW data centers to achieve total cost of ownership (TCO) optimization.

Features:

- The industry's leading power density per module at 55.6kVA in 3U space, and the smallest footprint for 500kVA in a single rack and 600kVA in two racks, to achieve the best utilization compared with its peers
- High AC-AC efficiency up to 96.5% and ECO mode to 99% resulting in marked energy cost savings
- Green mode featuring a load aggregation function optimizes system efficiency
- Fully modularized design and hot-swappable key modules ensure Mean Time To Repair (MTTR) close to zero without downtime risk
- Redundancy components and dual CAN bus delivers highest system availability and avoids single point of failure
- Modular UPS grows with your business by parallel expansion up to 8 units for 4.8MVA of total power capacity
- User-friendly 10" color touch screen enables easy local UPS management
- Environment information such as security, water, fire, and temperature can be integrated into the UPS for easy monitoring via the LCD of the UPS
- If the UPS is equipped with an external battery management system, the battery information can be integrated into the UPS and monitored via the LCD of the UPS

Applicable Sectors



Datacenter



Telecom



Industrial



Security



Lab



Medical



Network



Metro



Banking

Technical Specification

Model		DPH 50-500										DPH 500-600		
Power Rating	kVA*	50	100	150	200	250	300	350	400	450	500	500	550	600
	kW	50	100	150	200	250	300	350	400	450	450	500	550	600
	Number of Cabinet	1	1	1	1	1	1	1	1	1	1	2	2	2
	Number of Power Module	1	2	3	4	5	6	7	8	9	9	10	11	12
Input	Nominal Voltage	220/380V, 230/400V, 240/415V (3-phase, 4-wire + G)												
	Voltage Range	176 ~ 276 Vac (full load)												
	Current Harmonic Distortion	< 3%**												
	Power Factor	> 0.99												
	Frequency Range	40 ~70 Hz												
Output	Voltage	220/380V, 230/400V, 240/415V (3-phase, 4-wire + G)												
	Voltage Harmonic Distortion	≤ 0.5% (linear load)												
	Voltage Regulation	±1% (static)												
	Frequency	50/60 ± 0.05 Hz												
	Overload Capability	≤ 125% : 10 minutes ; ≤ 150% : 1 minute												
Display		10" color touch screen												
Interface	Standard	RS232 x 1, Parallel port x 4, USB x 3, Modbus x 1, Smart card slot x 1, REPO x 1, EPO x 1, Input dry contact x 4, Output dry contact x 6, Battery temperature sensor x 4, External switch detection x 4, RJ45 x 1, Ethernet x 1												
	Optional	Relay I/O card, Battery cabinet temperature sensor cable												
Conformance	Safety	CE												
Efficiency	AC-AC Mode	Up to 96.5%												
	ECO Mode	99%												
Battery	Nominal Voltage	±240 Vdc												
	Charge Voltage	±272V (adjustable from 204V to 312V)												
	Protection of Battery Deep Discharge	Yes												
Environment	Operating Temperature	0 ~ 40 °C												
	Relative Humidity	0 ~ 90% (non-condensing)												
	Audible Noise	<65 dB										<80 dB		
	IP Protection	IP 20												
Others	Parallel Redundancy and Expansion	Module and system redundancy ; Maximum 8 units												
	Emergency Power Off	Remote (default) and local (optional)												
	Battery Start	Yes												
Physical	Dimensions (W x D x H)	600 x 1100 x 2000 mm										1200 x 1100 x 2000 mm		
	Weight	353 kg	389 kg	425 kg	461 kg	497 kg	533 kg	569 kg	605 kg	641 kg	641 kg	965 kg	1001 kg	1037 kg

* The power module's power rating is adjustable to either 50kVA or 55.6kVA via touch panel.

** When input harmonic distortion is less than 1%.

All specifications are subject to change without prior notice.



2007-2008 Forbes Asia's Fabulous 50



2009 Frost & Sullivan Green Excellence Award for Corporate Leadership



Delta's Manufacturing System Certified by ISO 9001 and ISO 14001 Standards



IECQ Certificate of Hazardous Substance Process Management



UPS Management

SNMP IPv6 Card



Functions and features

■ Network

SNMP	SNMPv1/v3 protocol support; accepts NMS monitoring as well as actively sends Trap packets to target hosts Support IPv4 and IPv6 TCP/IP protocol
HTTP/HTTPS	Monitor and set up through network browser with built-in web server
Others	Telnet, SSH, FTP, SFTP, BOOTP, DHCP, SMTP, SNMP, WOL and RADIUS, Syslog
MIB	Supports RFC1628 and Delta proprietary UPSv4 MIB, UPSv5 MIB

■ Management

Regular power on and off	Can set up UPS power on and off time
Regular testing	Battery discharge test to ensure the battery is in good condition
Smart power off	Can send power off signal to connected host actively if the host computer has the InfraSuite Device Master or SNMP power off proxy installed
Probe	Optional environment probe can integrate ambient temperature and humidity for total cabinet monitoring

■ Diagnosis

Event log	Keep date, time, and event sequence in event log file
History records	Keep date, time, and UPS parameter data. Can be exported into XLS file for further processing

■ Reaction to events

UPS shutdown	Define delay time for UPS power off to avoid deep discharge
Email	Send email notification to predefined recipients in case of power event

■ Application

Integrate the communication requirement of UPS, PDC, STS, ATS and cooling with dip switches selection in one single SNMP IPv6 card

Technical specifications

10 / 100M RJ45 connector

Operation temperature 0 ~ 60° C

Input power 12 Vdc

Power consumption < 2W

Dimensions 130 X 60 mm

Weight 75 g

Relay I/O Card



Technical specifications

Operation temperature	0 ~ 40°C
Input power	8 ~ 20 Vdc
Power consumption	< 1.2W
Dimensions	130 x 60 mm
Weight	200g

Functions and features

■ Output

Programmable 6 output relays, each of them can be configured to represent one of the 20 UPS events respectively

NC/NO 6 output relays, each of them can be configured to either NC (Normal Close) or NO (Normal Open)

■ Input

Programmable The input signal can be configured to turn off the UPS or to issue battery test command

Modbus Card

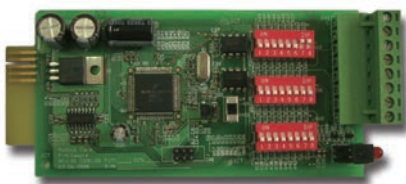

Technical specifications

Operation temperature	0 ~ 40°C
Input power	8 ~ 20 Vdc
Power consumption	< 1.2W
Dimensions	130 x 60 mm
Weight	150g

Convert status and parameter data of your UPS to comply with the standard Modbus protocol

Functions and features

Communications interface 1 x RS232 port; 1 x RS485 or RS422 port

- ID Device ID can be set to any number between 0~255
- Terminating resistor Terminating resistance of RS485 / 422 can be set by dip switch
- Modbus communications format Supports RTU format
- Baud rate 2400, 4800, 9600 or 19200
- Data bit 7 or 8
- Parity check None, even or odd

UPS Management

Mini SNMP IPv6 Card



Functions and features

■ Network

SNMP	SNMPv1, v2c and v3 protocols support; accepts NMS monitoring as well as actively sends Trap packets to target hosts; supports IPv4 and IPv6 TCP/IP protocol
Web	Monitor and set up through network browser with built-in web server
Protocol	HTTP, HTTPS, Modbus TCP, Telnet, SSH, FTP, SFTP, DHCP, SMTP, SNMP, RADIUS, Syslog, and WOL
MIB	Supports RFC1628 and Delta proprietary UPSv4 MIB, UPSv5MIB

■ Management

Regular power on and off	Can set up UPS power on and off time
Regular testing	Battery discharge test to ensure the battery is in good condition.
Smart Shutdown	Can send power off signal to connected host actively if the host computer has ShutdownAgent installed
Probe	Optional environment probe can integrate ambient temperature and humidity with 4 additional digital inputs for total cabinet monitoring

■ Diagnosis

Event log	Keep date, time, and event sequence in event log file
History records	Keep date, time, and UPS parameter data. Can be exported into XLS file for further processing

■ Reaction to events

UPS shutdown	Define delay time for UPS power off to avoid deep discharge
Email	Send email notification to predefined recipients in case of power event

Technical specifications

Network connection	RJ-45 jack connector
Operation temperature	0 ~ 60° C
Input power	12 Vdc
Power consumption	2 Watt Maximum
Dimensions	87 x 70 x 30 mm
Weight	75 g

Mini USB Card

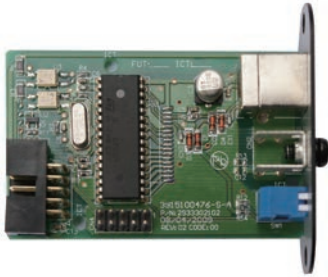

Functions and features

- Communication Protocol
SCI: Delta Regular v1.51
USB: Delta HID Protocol v3.4
- Support HID (Human Interface Device) protocol
The UPS can communicate with Windows XP/2003/2008/2012/Win7/Win8 without monitoring software
- Compatible with Delta UPS standard software: UPSentry 2012

Technical specifications

Dimensions	68 x 43 mm
Weight	30 g
Operating temperature	0 ~ 40° C
Input power	12 Vdc
Power consumption	0.5 Watts

Mini Dry Contact Card

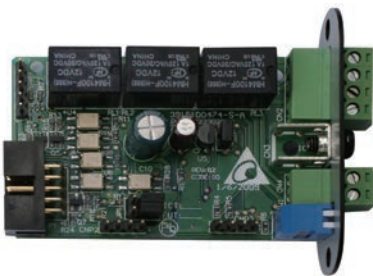

Functions and features

- UPS status information presented as 3 contact closures
- Configurable input signal as shutdown UPS or battery test
- Programmable output contact to monitor status of UPS
- Configurable UPS shutdown delay time
- Protects up to 3 computers
- Unattended graceful shutdown

Technical specifications

Dimensions	68 X 43 mm
Weight	35g
Operating temperature	0 ~ 40° C
Input power	8 ~ 20 Vdc
Power consumption	0.8 Watts

Mini TVSS Card



Functions and features

- This connection is optional but highly suggested as network lines often carry dangerous surges and spikes
- Connect the Network Protection Lines
Connect the network line from the wall to the connector marked “IN”, then connect the device (Ethernet card) to be protected to the connector marked “OUT”

Technical specifications

Dimensions	46 x 43 mm
Weight	25g
Operating temperature	0 ~ 40° C

Delta UPS Management Software

Communications mechanism

	RS232	USB	RS485	SNMP
UPSentry 2012	•	•		
InfraSuite Device Master	•		•	•
ShutdownAgent 2012				•

Key functions

	Shutdown OS	Centralized management	Remote control	Virtual Machine Shutdown			
				Hyper-v	ESXi	XenServer	KVM
UPSentry 2012	•		•	•		•	•
InfraSuite Device Master		•	•				
ShutdownAgent 2012	•			•	•	•	•

Operating system support

	Windows	Linux	FreeBSD	Sun Sparc
UPSentry 2012	•	•	•	•
InfraSuite Device Master	•			
ShutdownAgent 2012	•	•	•	•

Shutdown Agent 2012

Functions and features

- Support SNMPv1, v3 trap
- Provide web interface through HTTP and HTTPS
- Provide the batch configuration to deploy settings at a finger click
- Forward SNMP trap to extend protecting up to 255 servers
- Support up to 32 input trap sources for redundant (logical OR) and parallel (logical AND) application
- Provide console configuration for basic system parameters setup
- Support Windows 32/64 bits setup programs

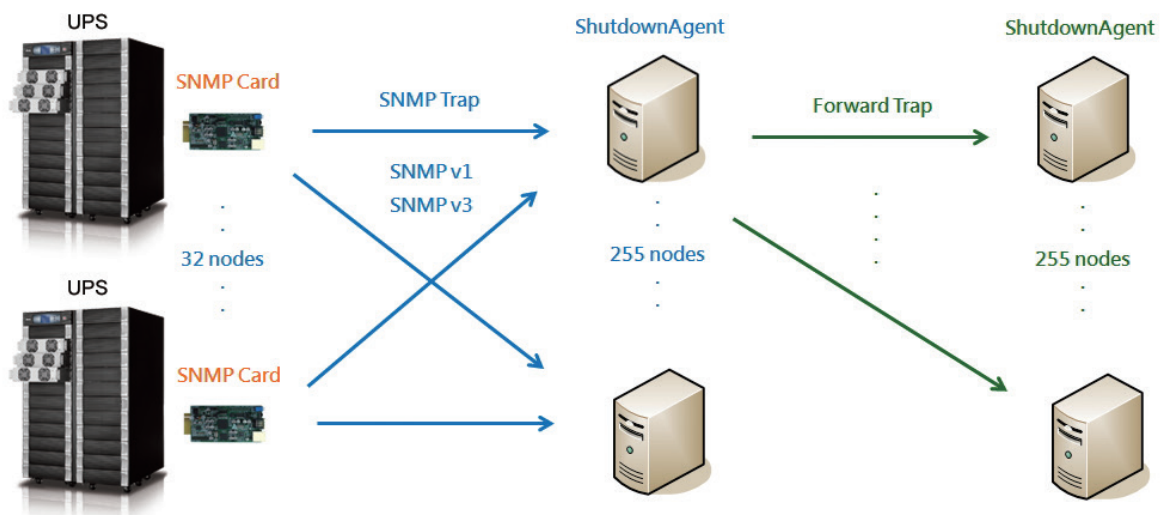

Operating system support

- Windows XP-sp2, Vista, 7, 8
- Windows 2003, 2008, 2012
- Windows 2008 Server Core, Hyper-V 2008 R2
- Linux OpenSUSE 11.4
- Linux ubuntu 10.04
- Linux Fedora 3.1.9
- CentOS 5.8
- VMWare ESXi 4.1, 5
- Citrix XenServer 6.0.0
- Linux KVM

Management System

UPSentry 2012

Functions and features

- Support RS232 and USB communication
- Provide web interface through HTTP and HTTPS
- Provide the batch configuration to deploy settings at a finger click
- Support SNMP Trap v1, v2c, v3
- Support SNMPv1, v3 server access for monitoring

Operating system support

- Windows XP-sp2, Vista, 7, 8
- Windows 2003, 2008, 2012
- Windows 2008 Server Core, Hyper-V 2008 R2
- Linux OpenSUSE 11.4
- Linux ubuntu 10.04
- Linux Fedora 3.1.9
- CentOS 5.8
- Citrix XenServer 6.0.0
- Linux KVM

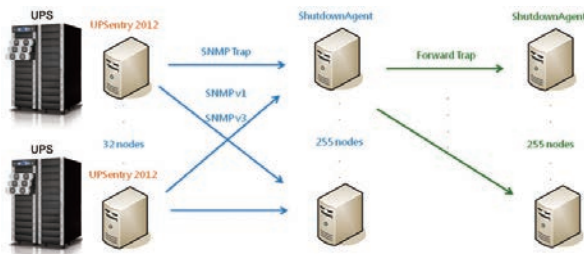

Scheduling

- Support scheduling shutdown, restart and battery test
- System power on/off
- 10 seconds test and deep discharge test

Web Interface

- Monitor UPS status through web interface
- System Summary: UPS identification, shutdown type, scheduling information and last five event log
- Battery: battery status, battery measurement, battery cabinet and replacement date
- In/Out/Bypass: Information of input measurement, bypass measurement and output measurement
- Identification: Information of identification and UPS rating

UPSentry 2012 status and configure shutdown arameters

- Work with ShutdownAgent 2012 to protect a huge number of hosts
- Provide console configuration for basic system parameters setup
- Support 32/64 bits software programs

Event Tracking

- Support 10,000 event log entries
- Display history values by a single date, month and year or a defined period of time
- Export data in csv. file format
- Clear the history data and event logs on the web interface



Shutdown Protection

- Input power fail
- Battery low
- Overload
- Bypass
- Schedule Shutdown

- Status Indication: Information of immediate UPS status indication
- Power Module: Information of power module bypass and power module ID1/2/3/4
- Shutdown Agent: Collect all of the ShutdownAgent 2012 which you assigned to work with UPSentry 2012 to protect a group of servers
- Display event log and history values

EnviroProbe



Functions and features

- LCD display
- Ambient temperature & humidity monitoring and water-leakage detection
- Digital & analog input/output contacts for monitoring and controlling other devices
- Supports SNMP communications protocol
- InfraSuite Device Master software for remote monitoring and recording

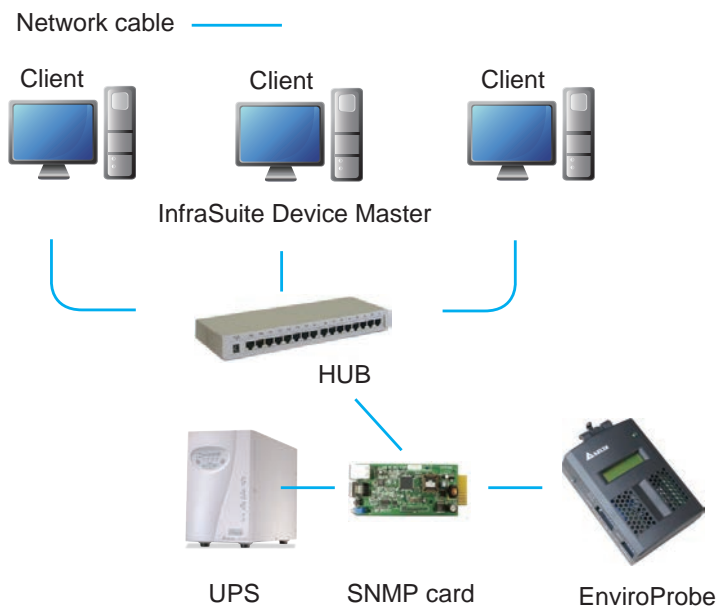

Technical specifications

Model	EMS1000	EMS1100	EMS1200
Input	EMS2000 Delta-BUS or SNMP Card: 12 Vdc (pin 1 & 4) with PDU SNMP card: 5Vdc (pin 2 & 4)		
Input/Output Contacts	4 inputs (dry/wet)	4 digital outputs	2 analog inputs, 1 analog output and 1 water-leakage detection.
Dimensions (W x D x H)	66 x 33 x 103 mm		
Weight	120g	130g	
Temperature	± 0.4°C @ 0°C ~ 60°C		
Humidity accuracy	±3% RH @ 0~80% RH		
Safety regulation compliance	CE, EN55022 Class B, EN55024		

Delta InfraSuite Device Master

InfraSuite Device Master provides a rich set of capabilities that simplify and automate critical device monitoring. It allows users to observe the status of all devices, query event logs or history data, and assists users in taking appropriate action. With cost effective deployment, this software solution is scalable to match your business growth.

Free to Download

InfraSuite Device Master is free to download with 5 nodes by default for monitoring your devices. Various infrastructure facilities such as power and cooling in a data center can be monitored.

Easy to Deploy

The download file is ready on the Delta Software website. InfraSuite Device Master is easy to install on your server or PC, with software designed for quick installation and implementation.

Real-Time Monitoring

Users can gather the latest status of critical facilities in a data center through the system screens of InfraSuite Device Master. InfraSuite Device Master also lets you view all of a site's device information, query history and events at the same time, even for multiple sites in different countries.

Migration to InfraSuite Manager (DCIM)

If you are not only looking for device monitoring but also a complete DCIM solution, InfraSuite Device Master is the quickest way of migrating to InfraSuite Manager, which is Delta's full feature DCIM software solution.

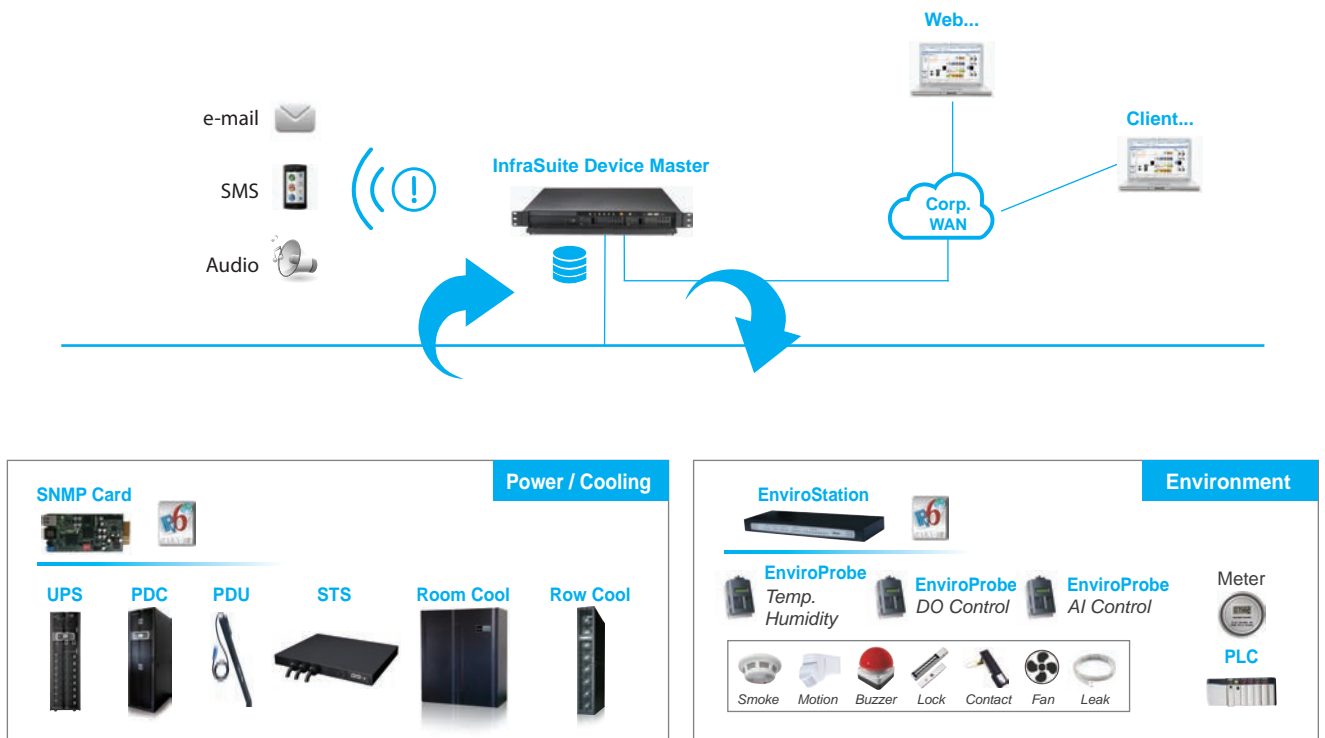

FIGURE 1. Delta InfraSuite Device Master Monitoring Application

Free Download To download InfraSuite Device Master, go to;
<http://www.deltapowersolutions.com/en/mcis/data-center-infrasuite-device-master.php>

Product Features

Navigational Graphics

Navigational graphics of the InfraSuite Device Master are customizable. Users can design a floor layout using the provided components.

Multiple Protocol Support

InfraSuite Device Master supports multiple device protocols, such as Modbus, SNMP and OPC.

Proactive Notification

Proactive notifications provide automated, personalized email, short messages, and audio to users.

User Account Management

Users can be classified into groups based on privilege levels. The job scope of each privilege level is defined by administrators. The jobs include the level of visible access to layout plans, device control and system operation.

Event Management

InfraSuite Device Master has categorized event levels with 16 levels to help users take appropriate action accordingly. Besides, events can be queried by time, type, level and devices. InfraSuite Device Master records the system, operator and device events in its database where the user can review the events' status.

Data Storage and Backup

InfraSuite Device Master stores all history events and data into its database. Users may use this data for analysis. In addition, the database can be backed up automatically according to user preference.

System Requirements

Model	InfraSuite Device Master (Server)	InfraSuite Device Master (Windows Application UI)	InfraSuite Device Master (Web Monitor UI)
Hardware	CPU: > 2GHz Memory: >= 4G Free HD Space: >= 50 G	CPU: > 2GHz Memory: >= 4G	CPU: > 2GHz Memory: >= 4G
Software	Support OS: Windows 7, 8, 10, Windows Server 2008, 2012, 2016	Supported OS: Windows 7, 8, 10, Windows Server 2008, 2012, 2016	Recommended Browser: Microsoft Internet Explorer v11, Google Chrome v30, Mozilla Firefox v23 and Safari v5.



FIGURE 2. Navigational Graphics

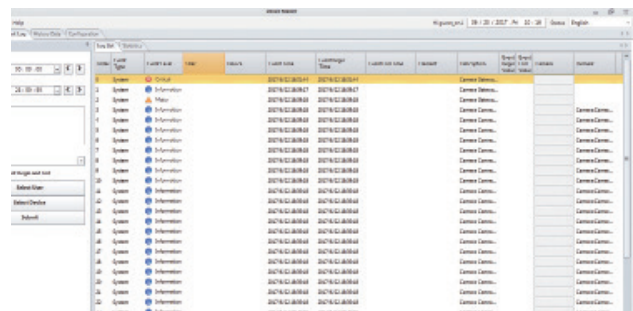

FIGURE 3. Event Log List

UPS Q&A

Power issues

Q What are the power issues?

A

Based on a survey made by Contingency Planning, poor power quality is the key factor in computer data loss. In addition to black outs, other power quality problems are: voltage sag, spikes, voltage surges, noise, and voltage too low (high). These are the events that lead to damage and reduce the life of computer components as well as cause data loss and damage.

Q How can these power issues be solved?

A

There are quite a few methods for dealing with power problems. The three most commonly used are: a surge absorber, a regulator or a UPS.

Power issue	Solution		
	Surge absorber	Regulator	Online UPS
Black out	X	X	✓
Sag	X	▲	✓
Surge	▲	▲	✓
Noise	X	X	✓
Spike	▲	▲	✓
Frequency drift	X	X	✓

X : Cannot deal with

▲ : Can partly deal with

✓ : Can totally deal with

Q What is a voltage sag? What is its impact on computer equipment?

A

Voltage sag is the most common power problem we may encounter and it is responsible for 87% of all power issues. A voltage sag is a short period of voltage drop caused by some outside problem. This may result in operation failure of computer peripherals, such as the keyboard in minor cases, or it might lead to data loss and file damage in its more serious form. Voltage sag may also damage computer components and reduce their working lives.

Q What is a spike? What is its impact on computer equipment?

A

A spike is a great increase in voltage of very short duration. In most cases it is generated by lightning in nearby regions. It may damage computer hardware or precision equipment and result in data loss.

Q What is a voltage surge? What is its impact on computer equipment?

A

When powering off high-current equipment or a group of high load equipment connected to a single power source, an inertial voltage surge may be generated during power transmission. Most computers or precision equipment feature a certain range of operational voltage that accommodates such a situation. However, if the voltage surge is greater than the tolerance settings, some equipment or components may be damaged and this can lead to equipment failure and a reduced working life.

Q What is noise? What is its impact on computer equipment?

A

A score of factors are responsible for noise, including lightning, the powering on or off of nearby equipment, generators, and even wireless communications. Noise may cause precision equipment or computers to fail or result in program runtime errors.



UPS Q&A

Types of UPS

Q Why is a UPS needed?

A

Unsteady power quality can affect the normal operation of a computer. A UPS not only provides immediate power in case of blackout, but also provides stable and clean power under normal conditions. It improves the incoming power by regulation and filtration and also suppresses spikes caused by lightning. A UPS, is like a personal insurance policy and protects your computer equipment against power risks.

Q What kinds of UPS are there?

A

There are three types of UPS: Off-Line On-Line and Line-Interactive.

Q What is an Off-Line UPS?

A

Please refer to the off-line system diagram.

Equipment is powered by the grid directly through a bypass line. In the event of a power failure it is powered by AC current generated by an inverter run by a battery in the UPS.

Features

1. When commercial power is normal, the UPS does nothing and the load is handled directly by the grid. This type does not improve grid power with respect to noise and surge suppression (filter typically used has low capacity).
2. Provides the least protection as a certain conversion time is needed.
3. Simple in structure, compact in size, light in weight, easy to control and not very expensive.

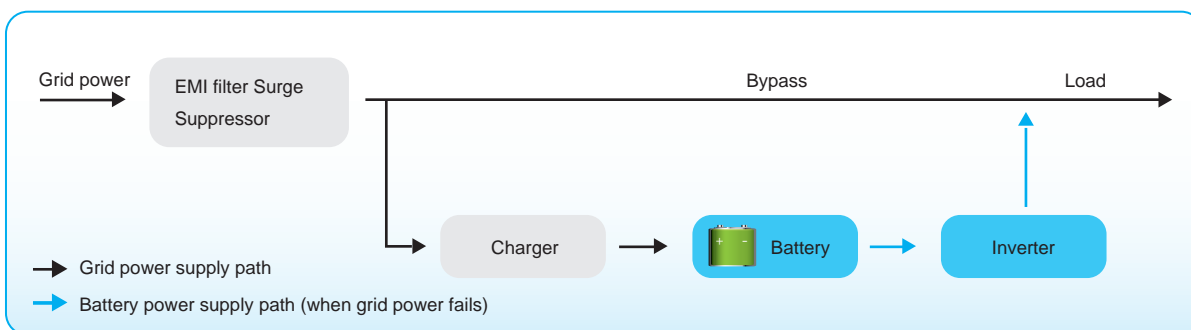

Q What is an On-Line UPS?

A

Please refer to the on-line UPS diagram.

The on-line UPS supplies power to the load by output from the inverter and uses the bypass path only in a case where the UPS itself fails, is overloaded, or overheats.

Features

1. Output power to the load is of the best quality as it is processed by the UPS.
2. No conversion time is required.
3. Complex in structure and expensive.
4. Gives the highest protection and has excellent noise filtering and surge suppression capacity.

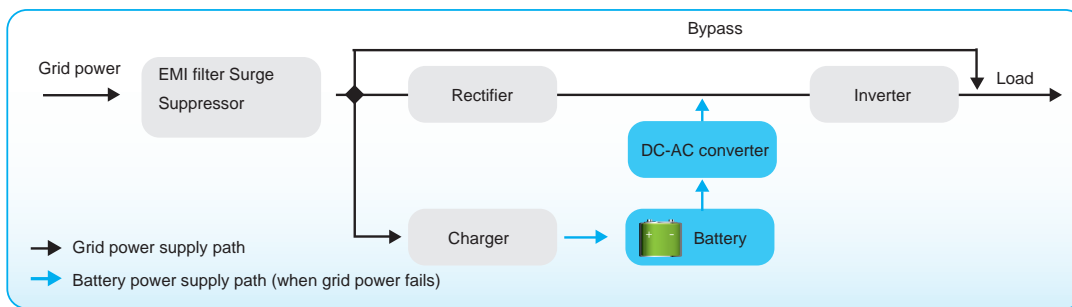

Q What is a Line-Interactive UPS?

A

Please refer to the line-interactive UPS diagram.

The line-interactive UPS supplies power to the load through the bypass path with output from the inverter when grid power is normal. The inverter acts as a charger at this time. In the event of a black out, the inverter converts DC current from the battery to AC for output to the load.

Features

1. The bi-directional conversion design reduces the time required for charging the UPS battery.
2. Requires a certain conversion time.
3. The complex control mechanism makes it more expensive.
4. Has protection capacity between that of the on-line and off-line UPSs. It is less effective in noise filtering and surge suppression.

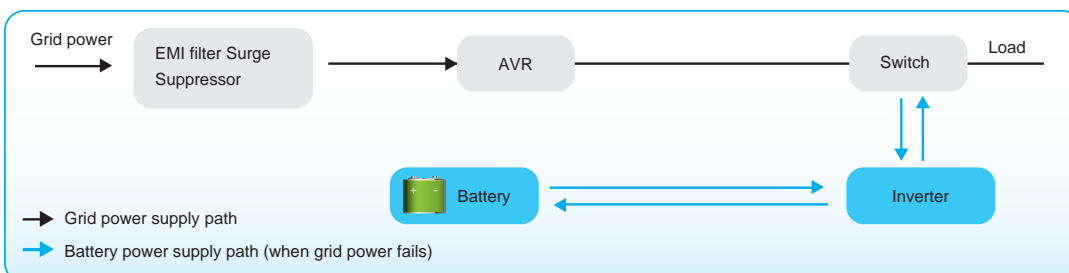

UPS Q&A

Common battery problems

Q What kinds of batteries are used in a UPS?

A

Most commercially available UPS use VRLA batteries that are water-and maintenance-free. The energy is generated by chemical reactions in a paste-like electrolyte. For most consumers, these batteries are not only easy to use and maintain but also simple to replace when necessary.

Q What is the life cycle of a battery?

A

The power provided by a UPS comes from the discharge of its batteries. Batteries age not only with use and external factors but also from the internal chemical reactions. Batteries will still age even when not in use.

Q How should a battery be maintained?

A

Regular charging and discharging is very important for battery maintenance. You can regularly execute this function if your UPS has the battery test feature. Otherwise, you can simply unplug the input to your UPS to simulate a grid power black-out and check the time the battery takes to discharge. Please replace your batteries with new ones when the discharge time becomes less than that given in the specification. This will ensure that there is enough discharge time for the system to save files and be shut down in case of grid power failure.

Q How is the capacity of a UPS determined?

A

Most commercially available UPS now express their capacity as VA. V stands for voltage and A for current in amps. In short, VA equals the power and capacity of a UPS. For example, a UPS of 500VA capacity with an output of 110V will provide a maximum current of 4.55A and more than this will lead to overload. The unit of power can be expressed in Watts. While the Watt indicates active power, VA indicates apparent power and Watt equals VA multiplied by the power factor ($VA \times pf = \text{Watt}$). There is no common criterion for power factor (pf). Generally a value of between 0.6 and 0.9 is acceptable while a value of 0.5 may represent poor design. Pay attention to this value when purchasing a UPS. A high power factor implies better utilization and more economical use of power.

Q Where can we have our batteries replaced?

A

Please contact the service center or your UPS dealer when you need to replace your batteries.

Q Where can an appropriate UPS be bought?

A

1. Learn about the applicability of each type of UPS.
2. Appraise your needs for power quality.
3. Learn the required UPS capacity and appraise the total capacity required for future expansion.
4. Select a market proven brand and supplier.
5. Purchase an appropriate UPS that is suitable for your requirements.

Q Is a UPS really needed in places with very few black-outs?

A

Statistics indicate that black-outs are a minor power issue. Other, not so obvious power issues, like over-voltage, under-voltage and surges are the major ones. In addition to providing extended power for long stretches, a UPS is designed to provide customers with critical total power protection against voltage drift, surges, high frequency interference, and any other kind of power failure and drift.

Q How long should the UPS provide power?

A

The single most important function of a UPS is to provide adequate backup power for the equipment load. The time a UPS should provide power should be long enough for users to finish running procedures in case of power failure. In general, 5 to 10 minutes should be enough. If longer than this is required, you can purchase a UPS that includes an external battery cabinet(s) that will increase the UPS backup time.

Europe

Czech Republic

Delta Energy Systems
(Czech Republic), spol.s r.o.
Perucka 2482/7, 120 00 Praha 2,
Czech Republic
T +420 272 019 330
E ups.czech.republic@deltaww.com

Finland

Delta Solutions (Finland) Oy
P.O. Box 63, Juvan teollisuuskatu 15, FIN-
02921 Espoo, Finland
T +358 9 84966 0
E ups.finland@deltaww.com

France

Delta Electronics (France) S.A.
ZI du bois Chaland 2, 15 rue des Pyrénées,
Lisses, 91056 Evry Cedex, France
T +33 1 69 77 82 60
E ups.france@deltaww.com

Germany

Delta Energy Systems (Germany) GmbH
Coesterweg 45, 59494 Soest, Germany
T +49 2921 987 0
E ups.germany@deltaww.com

The Netherlands - EMEA Headquarters

Delta Electronics (Netherlands) BV
Zandsteen 15, 2132MZ Hoofddorp,
The Netherlands
T +31 (0) 20 800 39 00
E ups.netherlands@deltaww.com

Poland

Delta Electronics (Poland) Sp. z o.o.
23 Poleczki Str., 02-822 Warszawa,
Poland
T +48 22 335 26 00
E ups.poland@deltaww.com

Russia

Delta Energy Systems LLC
Vereyskaya Plaza II, office 112, Vereyskaya
str.17, 121357 Moscow, Russia
T +7 495 644 3240
E ups.russia@deltaww.com

Slovak Republic

Delta Electronics (Slovakia) s.r.o.
Botanicka 25/A, SK - 841 04 Bratislava,
Slovakia
T +421 2 6541 1258
E ups.slovakia@deltaww.com

Switzerland

Delta Electronics (Switzerland) AG
Freiburgstrasse 251, 3018 Bern-Bümpliz,
Switzerland
T +41 31 998 53 11
E ups.switzerland@deltaww.com

Spain

Delta Electronics Solutions (Spain) SLU.
Ctra. de Villaverde a Vallecas, 265 1º Dcha Ed.
Hormigueras, 28031 - Madrid, Spain
T +34 91223 7420
E ups.spain@deltaww.com

Turkey

Delta Greentech Electronic San. Ltd.
Serifali Mevkii Barboros Bulvari Soylesi Sok No
19 Y.Dudullu-Umraniye/Istanbul, Turkey
T +90 216 499 9910
E ups.turkey@deltaww.com

United Kingdom

Delta Electronics Europe Ltd.
1 Redwood Court, Peel Park, Campus, East
Kilbride, G74 5PF, United Kingdom
T +44 1355 588 888
E ups.united.kingdom@deltaww.com

Middle-East & Africa

South Africa

Delta Energy Systems MEA (Switzerland) AG
South Africa Representative Office
Unit 305B, Lougardia Building, Cnr
Embankment and Hendrik Verwoerd Drive,
Centurion, 0157, South Africa
T +27 12 663 2714
E ups.south.africa@deltaww.com

United Arab Emirates

Delta Energy Systems (Switzerland) AG
Dubai Representative Office
P.O. Box 185668
Gate 7, 3rd Floor, Hamarain Centre, Dubai
T +971 425 99 55 3
E info.middle-east@deltaww.com

Americas

Brazil

Delta Greentech (Brasil) S/A
Rua Itapeva, Nº 26 - 3º andar
01332 000 - São Paulo - SP
T +55 11 3530 8658
E ups.brazil@deltaww.com

The United States

Delta Electronics (Americas) Ltd.
46101 Fremont Blvd.
Fremont, CA 94538
T +1 510 344 2157
E ups.na@deltaww.com

Asia Pacific

Australia

Delta Electronics (Australia) Pty Ltd.
Unit 20-21, 45 Normanby Road, Notting
Hill VIC 3168, Australia
T +61 3 9543 3720
E ups.australia@deltaww.com

Sydney office:

Level 3 / 67-69 Epping Rd, North Ryde, NSW 2113

China

Delta GreenTech (China) Co., Ltd.
238 Minxia Road, Pudong, Shanghai, 201209
P.R.C
T +86 21 5863 5678 / +86 21 5863 9595
E ups.china@deltaww.com

India

Delta Power Solutions (India) Pvt. Ltd.
Plot No. 43, Sector-35, HSIIDC,
Gurgaon-122001, Haryana, India
T +91 124 4874 900
E ups.india@deltaww.com

Indonesia

Wisma Aldiron 1st Floor, Suite 140, Jl. Jend.
Gatot Subroto Kav. 72, Jakarta 12780,
Indonesia
E ups.indonesia@deltaww.com

South Korea

Delta Electronics (Korea), Inc.
1511, Byucksan Digital Valley 6-cha, Gasan-
dong, Geumcheon-gu, Seoul, Korea 153-704
T +82 2 515 5303
E ups.south.korea@deltaww.com

Malaysia

C-05-08, LEVEL 05, BLOCK C, SKYPARK
One City, Jalan USJ 25/1
47650 Subang Jaya
Selangor Darul Ehsan, Malaysia
E ups.malaysia@deltaww.com

Philippines

10/F Unit 1001, Richmond Plaza,
San Miguel Avenue, Ortigas Center,
Pasig City 1600 Metro Manila, Philippines
E ups.philippines@deltaww.com

Singapore

Delta Energy Systems (Singapore) Pte Ltd.
4 Kaki Bukit Ave 1, #05-04, Singapore
417939
T +65 6747 5155
E ups.singapore@deltaww.com

Taiwan

Delta Electronics Inc.
39 Section 2, Huandong Road,
Shanhua Township
Tainan County 74144, Taiwan
T +886 6 505 6565
E ups.taiwan@deltaww.com

Thailand

Delta Electronics (Thailand) Public Co., Ltd.
909 Soi 9, Moo 4, E.P.Z., Bangpoo
Industrial Estate, Tambon Prakasa,
Amphur Muang-samutprakarn,
Samutprakarn Province 10280, Thailand
T +662 709-2800
E ups.thailand@deltaww.com

Vietnam

Delta Vietnam REP Office
3rd floor, RIC Building, 51 Hoang Viet, Tan Binh,
Ho Chi Minh City Vietnam
E ups.vietnam@deltaww.com



Smarter. Greener. Together.